

PRICE LIST 2025

HOWE

FLEXIBILITY
DELIVERED
WITH PASSION



Table of Content

Chairs

40/4	4
Side chair	4
Side chair - upholstered	5
Side chair Xtra	6
Arm chair	7
Arm chair - upholstered	8
Swivel	9
Swivel - upholstered	10
Bar and Lounge	11
Metal and Wood	12
SixE	13
4-leg	13
4-leg on castors	14
Sled	15
Barstool	16
Swivel	17
Learn	18
MN1	19
Cantilever	19
X-base	20
5-star	21
AS100	22
Accessories for chairs	23
Notes for chairs	30
<hr/>	
Upholstery collection	31





Table of Content

Tables

Moveo	36
Training	36
Meeting	37
Conference, modular	38
Conference, stand alone	39
Modesty panel	40
Simpla	41
Tables	41
Modesty panel	43
Tempest	44
Flip top	44
Fold	46
Fix	47
Flip top café	49
Fix café and lounge	50
Flip top bar	51
Fix bar	52
Drop-in top	53
Modesty panel	54
Tutor	55
AS table series	56
AS400	56
AS500	57
Folding Surfaces	58
Other accessories for tables	59
Notes for tables	67
Finish overview	69
Sales Terms	74
Shipping zone rates	78
Warranty	79



40/4 side chair - polyamide and veneer

By David Rowland

Most people see the 40/4 as a pioneering design that has stood the test of time. We like to think of it as a legacy that continues to move you in new ways.

- 10 year warranty
- Stacks 40 chairs on a dolly
- EN 15373 / ANSI/BIFMA X5.1 – M7.1
- GreenTag^{Cert™}
- **Quick ship - LINK**
- FSC wood certified



	POLYAMIDE (DPA)		VENEER (DVA)					
STANDARD FRAME COLOURS	PA200 ● PA100 ● V2 ● V1 ● LW17 ●	PA300 ○ PA110 ● V3 ● V5 ● LW30 ●	PA250 ● V13 ● V15 ● V12 ●	PA260 ●	PA320 ●	PA360 ●	PA380 ●	PA370 ●
 B1 B6 B7 B9 B10 B30								
RAL K7 colours available at customer request	\$	\$	\$	\$	\$			
Non linking (RA) 14.3 lbs								
	489	528	711	759	823			
Brace linking (BA) 14.6 lbs								
	556	595	780	828	892			
Side chair outdoor (DOARA) 14.3 lbs								
	731	770	N/A	N/A	N/A			

Price List 2024 - USD excl. sales tax - Version 1.1

Felt glides	20	\$
Fee per RAL K7 colour for frames (for one colour if below 200 pcs)	+520	\$
Fee per RAL K7 colour for veneer (for one colour if below 200 pcs)	+520	\$

40/4 side chair upholstered

By David Rowland

Most people see the 40/4 as a pioneering design that has stood the test of time. We like to think of it as a legacy that continues to move you in new ways.

- 10 year warranty
- Stacks 25 chairs on a dolly
- EN 16139 / Ansi/Bifma X5.1
- GreenTag^{Cert™}
- FSC wood certified



STANDARD FRAME COLOURS

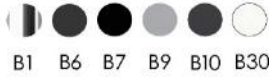

RAL K7 colours available at customer request

Non linking (RA)

13.9 lbs

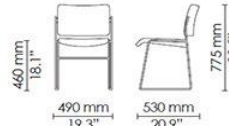

Brace linking (BA)

14.3 lbs

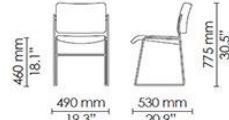

GROUP	SEAT UPHOLSTERED					FULLY UPHOLSTERED (DUA)												
	POLYAMIDE (DSA)		VENEER (DTA)															
	PA200	PA300	PA100	PA110	PA250		PA260	PA320	PA360	PA380	PA370	V2	V3	V13	V1	V5	V15	V12
	\$	\$	\$	\$	\$	\$												
COM	627	651	848	878	922	711												
1	666	690	887	917	961	767												
2	718	742	939	969	1013	841												
3	768	792	989	1019	1063	914												
4	845	869	1066	1096	1140	1023												
5	871	895	1092	1122	1166	1059												
COL	785	809	1006	1036	1080	938												
LUBL	845	869	1066	1096	1140	1023												
LUCL	947	971	1168	1198	1242	1169												
LSL	1109	1133	1330	1360	1404	1399												
COM	694	718	915	945	989	780												
1	733	757	954	984	1028	836												
2	785	809	1006	1036	1080	910												
3	835	859	1056	1086	1130	983												
4	912	936	1133	1163	1207	1092												
5	938	962	1159	1189	1233	1128												
COL	852	876	1073	1103	1147	1007												
LUBL	912	936	1133	1163	1207	1092												
LUCL	1014	1038	1235	1265	1309	1238												
LSL	1176	1200	1397	1427	1471	1468												

Price List 2024 - USD excl. sales tax - Version 1.1

Felt glides	20	\$
Fee per RAL K7 colour for frames (for one colour if below 200 pcs)	+520	\$
Fee per RAL K7 colour for veneer (for one colour if below 200 pcs)	+520	\$

40/4 side chair Xtra

By David Rowland

Most people see the 40/4 as a pioneering design that has stood the test of time. We like to think of it as a legacy that continues to move you in new ways.

- 10 year warranty
- Stacks 40 chairs on a dolly
- EN 16139 / Ansi/Bifma X5.1
- GreenTag^{Cert™}
- 1.6" wider and 0.2" higher than the standard 40/4
- FSC wood certified

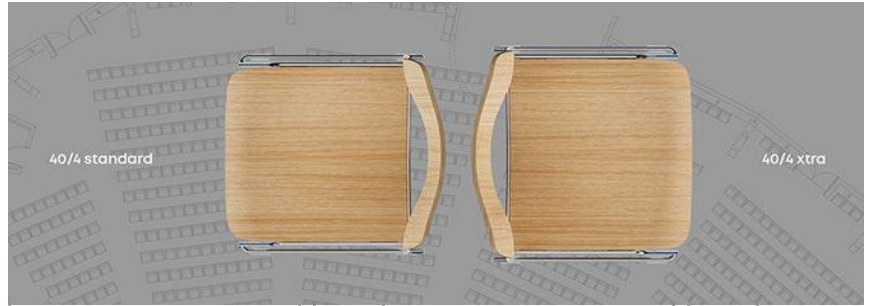

STANDARD FRAME COLOURS	VENEER (DVQ)			GROUP	VENEER WITH UPH. SEAT (DTQ)			FULLY UPHOLSTERED (DUQ)
	V2 V3 V13	V1 V5 V15 V12	LW17 LW30		V2 V3 V13	V1 V5 V15 V12	LW17 LW30	
<p>B1 B6 B7 B9 B10 B30</p> <p>RAL K7 colours available at customer request</p>	\$	\$	\$		\$	\$	\$	\$
Non linking (RA) 13.9 lbs 	818	866	930	COM 977 1 1016 2 1068 3 1118 4 1195 5 1221 COL 1135 LUBL 1195 LUCL 1297 LSL 1459	1007 1046 1098 1148 1225 1251 1165 1225 1327 #N/D	1051 1090 1142 1192 1269 1295 1209 1209 1209	818 874 948 1021 1130 1166 1045 1130 1276 1506	
Brace linking (BA) 14.1 lbs 	887	935	999	COM 1044 1 1083 2 1135 3 1185 4 1262 5 1288 COL 1202 LUBL 1262 LUCL 1364 LSL 1526	1074 1113 1165 1215 1292 1318 1232 1292 1394	1118 1157 1209 1259 1336 1362 1276 1276 1276	887 943 1017 1090 1199 1235 1114 1199 1345 1575	

Price List 2024 - USD excl. sales tax - Version 1.1

Felt glides	20	\$
Fee per RAL K7 colour for frames (for one colour if below 200 pcs)	+520	\$
Fee per RAL K7 colour for veneer (for one colour if below 200 pcs)	+520	\$

40/4 armchair - polyamide and veneer

By David Rowland

Most people see the 40/4 as a pioneering design that has stood the test of time. We like to think of it as a legacy that continues to move you in new ways.

- 10 year warranty
- Stacks 40 chairs on a dolly
- EN 15373 / ANSI/BIFMA X5.1 – M7.1
- GreenTag^{Cert™}
- FSC wood certified

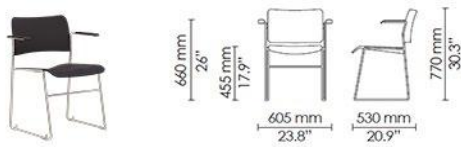
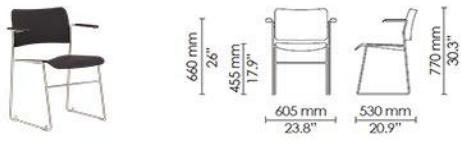
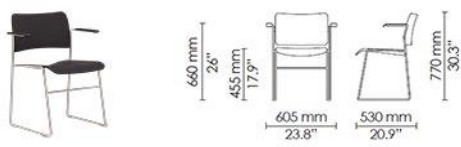

	POLYAMIDE (DPB)		VENEER (DVB)			
STANDARD FRAME COLOURS	PA200 ● PA300 ○	PA100 ● PA110 ● PA250 ● PA260 ● PA320 ● PA360 ● PA380 ● PA370 ●	V2 ● V3 ● V13 ●	V1 ● V5 ● V15 ● V12 ●	LW17 ● LW30 ○	
 B1 B6 B7 B9 B10 B30						
RAL K7 colours available at customer request	\$	\$	\$	\$	\$	
Non linking (RA) 17 lbs		677	716	897	945	1009
Armlinking (J) 17.2 lbs		787	826	1007	1055	1119
Armchair outdoor (DOBRA) 17 lbs		919	958	N/A	N/A	N/A

Price List 2024 - USD excl. sales tax - Version 1.1

Felt glides	20	\$
Table surface protection	+23	\$
Fee per RAL K7 colour for frames (for one colour if below 200 pcs)	+520	\$
Fee per RAL K7 colour for veneer (for one colour if below 200 pcs)	+520	\$

40/4 armchair upholstered

By David Rowland

Most people see the 40/4 as a pioneering design that has stood the test of time. We like to think of it as a legacy that continues to move you in new ways.

- 10 year warranty
- Stacks 25 chairs on a dolly
- EN 15373 / ANSI/BIFMA X5.1 – M7.1
- GreenTag^{Cert™}
- FSC wood certified



STANDARD FRAME COLOURS



RAL K7 colours available at customer request

Non linking (RA)

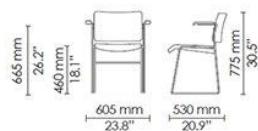

16.8 lbs

Armlinking (J)



17 lbs

GROUP	SEAT UPHOLSTERED					FULLY UPHOLSTERED (DUB)		
	POLYAMIDE (DSB)		VENEER (DTB)			BLACK POLYAMIDE ARMREST	BLACK STAINED VENEER ARMREST	UPH. ARMRESTS
	PA200 PA300	PA100 PA110 PA250 PA260 PA320 PA360 PA380 PA370	V2 V3 V13	V1 V5 V15 V12	LW17 LW30			
	\$	\$	\$	\$	\$	\$	\$	\$
COM	815	839	1036	1066	1110	898	972	972
1	854	878	1075	1105	1149	954	1028	1053
2	906	930	1127	1157	1201	1028	1102	1143
3	956	980	1177	1207	1251	1101	1175	1229
4	1033	1057	1254	1284	1328	1210	1284	1350
5	1059	1083	1280	1310	1354	1246	1320	1408
COL	973	997	1194	1224	1268	1125	1199	1242
LUBL	1033	1057	1254	1284	1328	1210	1284	1350
LUCL	1135	1159	1356	1386	1430	1356	1430	1557
LSL	1297	1321	1518	1548	1592	1586	1660	1805
COM	925	949	1146	1176	1220	1008	1082	1082
1	964	988	1185	1215	1259	1064	1138	1163
2	1016	1040	1237	1267	1311	1138	1212	1253
3	1066	1090	1287	1317	1361	1211	1285	1339
4	1143	1167	1364	1394	1438	1320	1394	1460
5	1169	1193	1390	1420	1464	1356	1430	1518
COL	1083	1107	1304	1334	1378	1235	1309	1352
LUBL	1143	1167	1364	1394	1438	1320	1394	1460
LUCL	1245	1269	1466	1496	1540	1466	1540	1667
LSL	1407	1431	1628	1658	1702	1696	1770	1915

Price List 2024 - USD excl. sales tax - Version 1.1

Felt glides	20	\$
Table surface protection	+23	\$
Fee per RAL K7 colour for frames (for one colour if below 200 pcs)	+520	\$
Fee per RAL K7 colour for veneer (for one colour if below 200 pcs)	+520	\$

40/4 swivel - polyamide and veneer

By David Rowland

Most people see the 40/4 as a pioneering design that has stood the test of time. We like to think of it as a legacy that continues to move you in new ways.

- 10 year warranty
- Castors or glides available
- Height adjustable
- Soft castors as an option
- GreenTag^{Cert™}
- FSC wood certified

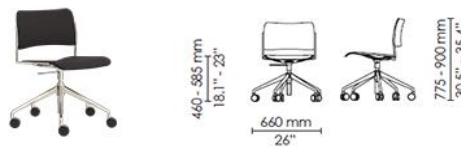
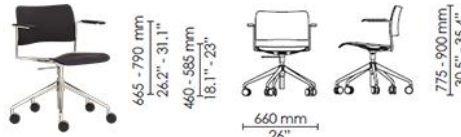

	POLYAMIDE (DP)		VENEER (DV)					
STANDARD FRAME COLOURS	PA200 ● PA100 ● V2 ● V1 ● LW17 ●	PA300 ○ PA110 ● V3 ● V5 ● LW30 ●	PA250 ● V13 ● V15 ●	PA260 ● V12 ●	PA320 ●	PA360 ●	PA380 ●	PA370 ●
								
B1 B6 B7 B9 B10 B30								
RAL K7 colours available at customer request								
Side chair (DPESS) 25.6 lbs	\$	\$	\$	\$	\$			
	911	950	1 125	1 173	1 237			
Armchair (DPFSA) 27.3 lbs								
	1 101	1 140	1 311	1 359	1 423			

Price List 2024 - USD excl. sales tax - Version 1.1

Soft lane castors	20	\$
Fee per RAL K7 colour for frames (for one colour if below 200 pcs)	+520	\$
Fee per RAL K7 colour for veneer (for one colour if below 200 pcs)	+520	\$

40/4 barstool and lounge chair

By David Rowland

Most people see the 40/4 as a pioneering design that has stood the test of time. We like to think of it as a legacy that continues to move you in new ways.

- 10 year warranty
- Stacks up to 10 barstools on the follor
- Stacks up to 20 lounge chairs on the floor
- EN 15373 / ANSI/BIFMA X5.1
- FSC wood certified
- GreenTag^{Cert™}



STANDARD FRAME COLOURS	POLYAMIDE		VENEER			FULLY UPHOLSTERED	
	GROUP	PRICE	GROUP	PRICE	GROUP	PRICE	PRICE
<p>B1 B6 B7 B9 B10 B30</p> <p>RAL K7 colours available at customer request</p>	PA200 ● PA100 ● V2 ● V1 ● LW17 ● PA300 ○ PA110 ● V3 ● V5 ● LW30 ● PA250 ● V13 ● V15 ● PA260 ● V12 ● PA320 ● PA360 ● PA380 ● PA370 ●	\$	\$	\$	\$	\$	
Lounge chair (DVDRA) 13.2 lbs 	N/A	N/A	895	943	1 007		COM 984 1 1040 2 1114 3 1187 4 1296 5 1332 COL 1211 LUBL 1296 LUCL 1442 LSL 1672
Barstool (DPCAA) 22.9 lbs 	900	939	1 123	1 171	1 235		COM 1123 1 1179 2 1253 3 1326 4 1435 5 1471 COL 1350 LUBL 1435 LUCL 1581 LSL 1811
Barstool counter height (DPCCA) 20.3 lbs 	900	939	1 123	1 171	1 235		COM 1123 1 1179 2 1253 3 1326 4 1435 5 1471 COL 1350 LUBL 1435 LUCL 1581 LSL 1811
Barstool outdoor (DOCCA) 22.9 lbs 	1 144	1 183	N/A	N/A	N/A		

Price List 2024 - USD excl. sales tax - Version 1.1

Felt glides	20	\$
Fee per RAL K7 colour for frames (for one colour if below 200 pcs)	+520	\$
Fee per RAL K7 colour for veneer (for one colour if below 200 pcs)	+520	\$

40/4 wood frame and 40/4 metal

By David Rowland

Most people see the 40/4 as a pioneering design that has stood the test of time. The 40/4 wood frame is an alternative to the original chair with its iconic steel rod sled frame

- 10 year warranty
- Stacks 25 chairs with wood frame
- Stacks 40 chairs in metal
- Wood frame also with seat upholstered
- EN 16139 (wood frame)
- GreenTag^{Cert™}
- FSC wood certified

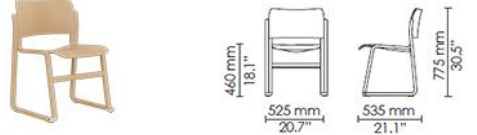
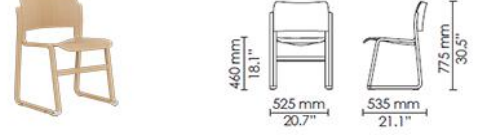
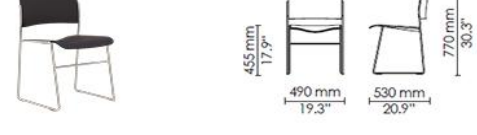

	METAL (DMA)		VENEER (DWAAK)		SEAT UPHOLSTERED (DRAAK)		
	ME200 ME300	V2 V3	V3 V3	LW17 LW25	GROUP	V2 V3	LW17 LW25
Wood seat and back matches the frame  V2 V3 LW17 LW25							
Wood non linking (DWAAK-N) 10.4 lbs 	N/A	835	911	969			
Wood w/ linking (DWAAK-Y) 10.8 lbs 	N/A	880	956	1014			
Metal non linking (DMA-N) 18.7 lbs 	714	N/A	N/A	N/A			

	V2	V3	LW17	LW25
COM	978	1054	1112	
1	1017	1093	1151	
2	1069	1145	1203	
3	1119	1195	1253	
4	1196	1272	1330	
5	1222	1298	1356	
COL	1136	1212	1270	
LUBL	#N/D	1272	1330	
LUCL	1298	1374	1432	
LSL	1460	1536	1594	
COM	1023	1099	1157	
1	1062	1138	1196	
2	1114	1190	1248	
3	1164	1240	1298	
4	1241	1317	1375	
5	1267	1343	1401	
COL	1181	1257	1315	
LUBL	#N/D	1317	1375	
LUCL	1343	1419	1477	
LSL	1505	1581	1639	

Price List 2024 - USD excl. sales tax - Version 1.1

Felt glides	20	\$
Fee per RAL K7 colour for frames (for one colour if below 200 pcs)	+520	\$
Fee per RAL K7 colour for veneer (for one colour if below 200 pcs)	+520	\$

SixE 4-leg

By PearsonLloyd

No matter how you look at SixE, it presents itself as a perfectly bold move – bending the rules of how comfortable a simple polypropylene shell chair can be.

- 10 year warranty
- SixE stacks up to 25 chairs on a dolly
- GreenTag^{Cert™}
- **Quick ship - LINK**



Standard frame colours: B1 B6 B7 B9 B10 B30 Choose matching frame and shell colour without additional costs: 	POLYPROPYLENE (EPAMA/EPBMA)		UPHOLSTERY					
	PP200 ●	PP100 ● PP300 ○ PP310 ● PP270 ● PP120 ● PP340 ● PP350 ●	RECYCLED PP200 ●	RECYCLED PP100 ● PP300 ○ PP120 ●	SEAT UPH.		FULLY UPH.	
					BLACK (EFA/EFB)	COLOUR (EFA/EFB)	NO ARM (EUA)	BLACK ARM (EUB)
RAL K7 colours available at customer request	\$	\$			\$	\$	\$	\$
Sidechair (EPAMA) 11 lbs		370	418					
Sidechair with Quicklinking (EPAMA-R) 11 lbs		447	495					
Armchair (EPBMA) 12.6 lbs		495	543					
Armchair with armlinking (EPBMA-Y) 12.6 lbs		516	564					
				GROUP				
					\$	\$	\$	\$
				COM	599	647	1014	N/A
				1	630	678	1110	N/A
				2	664	712	1208	N/A
				3	689	737	1285	N/A
				4	731	779	1413	N/A
				5	774	822	1536	N/A
				COL	710	758	N/A	N/A
				LUBL	731	779	N/A	N/A
				LUCL	833	881	N/A	N/A
				LSL	943	991	N/A	N/A
				COM	676	724	1091	N/A
				1	707	755	1187	N/A
				2	741	789	1285	N/A
				3	766	814	1362	N/A
				4	808	856	1490	N/A
				5	851	899	1613	N/A
				COL	787	835	N/A	N/A
				LUBL	808	856	N/A	N/A
				LUCL	910	958	N/A	N/A
				LSL	1020	1068	N/A	N/A
				COM	733	781	N/A	1137
				1	764	812	N/A	1233
				2	798	846	N/A	1331
				3	823	871	N/A	1408
				4	865	913	N/A	1536
				5	908	956	N/A	1659
				COL	844	892	N/A	N/A
				LUBL	865	913	N/A	N/A
				LUCL	967	1015	N/A	N/A
				LSL	1077	1125	N/A	N/A
				COM	754	802	N/A	1158
				1	785	833	N/A	1254
				2	819	867	N/A	1352
				3	844	892	N/A	1429
				4	886	934	N/A	1557
				5	929	977	N/A	1680
				COL	865	913	N/A	N/A
				LUBL	886	934	N/A	N/A
				LUCL	988	1036	N/A	N/A
				LSL	1098	1146	N/A	N/A

Price List 2024 - USD excl. sales tax - Version 1.1

Felt glides 21 \$

Fee per RAL K7 colour for frames (for one colour if below 200 pcs) +520 \$



SixE 4-leg on castors

By PearsonLloyd

No matter how you look at SixE, it presents itself as a perfectly bold move – bending the rules of how comfortable a simple polypropylene shell chair can be.

- 10 year warranty
- SixE stacks up to 15 chairs on a dolly
- GreenTag^{Cert™}

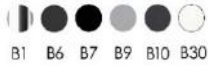

Standard frame colours:  B1 B6 B7 B9 B10 B30 Choose matching frame and shell colour without additional costs: 	POLYPROPYLENE (EPASC/EPBSE)		UPHOLSTERY					
	PP200 ●	PP100 ● PP300 ○ PP310 ● PP270 ● PP120 ● PP340 ● PP350 ●	RECYCLED PP200 ●	RECYCLED PP100 ● PP300 ○ PP120 ●	SEAT UPH.		FULLY UPH.	
					BLACK (EFA/EFB)	COLOUR (EFA/EFB)	NO ARM (EUA)	BLACK ARM (EUB)
RAL K7 colours available at customer request	\$	\$			\$	\$	\$	\$
Sidechair (EPA) 17.42 lb		604	702	COM	854	902	1246	N/A
				1	885	933	1342	N/A
				2	919	967	1440	N/A
				3	944	992	1517	N/A
				4	986	1034	1645	N/A
				5	1029	1077	1768	N/A
				COL	965	1013	N/A	N/A
				LUBL	986	1034	N/A	N/A
				LUCL	1088	1136	N/A	N/A
				LSL	1198	N/A	N/A	N/A
Armchair (EPB) 20.3 lb		727	775	COM	988	1036	N/A	1371
				1	1019	1067	N/A	1467
				2	1053	1101	N/A	1565
				3	1078	1126	N/A	1642
				4	1120	1168	N/A	1770
				5	1163	1211	N/A	1893
				COL	1099	1147	N/A	N/A
				LUBL	1120	1168	N/A	N/A
				LUCL	1222	1270	N/A	N/A
				LSL	1332	N/A	N/A	N/A

Price List 2024 - USD excl. sales tax - Version 1.1

Soft lane castors 21 \$

Fee per RAL K7 colour for frames (for one colour if below 200 pcs) +520 \$

SixE sled







By PearsonLloyd

No matter how you look at SixE, it presents itself as a perfectly bold move – bending the rules of how comfortable a simple polypropylene shell chair can be.

- 10 year warranty
- SixE stacks up to 25 chairs on a dolly
- GreenTag^{Cert™}

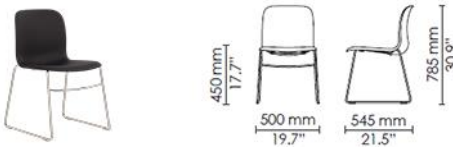

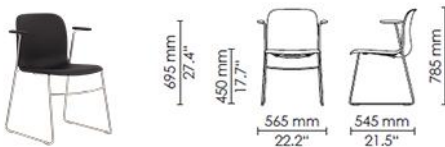
Photo: Steve Hall / Architect: Eastlake Studio

Standard frame colours:  B1 B6 B7 B9 B10 B30 Choose matching frame and shell colour without additional costs: 	POLYPROPOYLENE (EPA/EPB)		UPHOLSTERY				
	PP200 ● RECYCLED PP200 ●	PP100 ● PP300 ○ PP310 ○ PP270 ● PP120 ● PP340 ● PP350 ● RECYCLED PP100 ● RECYCLED PP300 ○ RECYCLED PP120 ●	GROUP	SEAT UPH.		FULLY UPH.	
				BLACK (EFA/EFB)	COLOUR (EFA/EFB)	NO ARM (EUA)	BLACK ARM (EUB)
RAL K7 colours available at customer request	\$	\$		\$	\$	\$	\$
Sidechair (EPARB) 13.2 lbs 	460	508					
Sidechair with bracelinking (EPABB) 13.7 lbs 	539	587					
Armchair (EPBRB) 16.1 lbs 	585	633					
Armchair with armlinking (EPBRB-Y) 16.1 lbs 	606	654					
			COM				
			1				
			2				
			3				
			4				
			5				
			COL				
			LUBL				
			LUCL				
			LSL				

Price List 2024 - USD excl. sales tax - Version 1.1

Felt glides	21	\$
Fee per RAL K7 colour for frames (for one colour if below 200 pcs)	+520	\$



SixE swivel

By PearsonLloyd

No matter how you look at SixE,
it presents itself as a perfectly bold move.
– bending the rules of how comfortable
a simple polypropylene shell chair can be.

- 10* year warranty
- Design for Disassembly
- GreenTag^{Cert™}

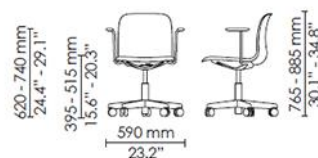

Standard frame colours:		POLYPROPYLENE (EPEES/EPFES)		UPHOLSTERY			
		PP200 ●	PP100 ●	GROUP	SEAT UPH.		FULLY UPH. (EFSES/ EFTES)
BAIN - HOWE Grey		PP300 ○	PP310 ●		BLACK (EPO/ EPP)	COLOUR (EPO/ EPP)	
		PP270 ●	PP120 ●				
		PP340 ●	PP350 ●				
		RECYCLED PP200 ●	RECYCLED PP100 ●				
			PP300 ○				
			PP120 ●				
		\$	\$				
Sidechair	15.9 lbs			COM	889	937	1286
		645	693	1	920	968	1382
				2	954	1002	1480
				3	979	1027	1557
				4	1021	1069	1685
				5	1064	1112	1808
				COL	1000	1048	N/A
				LUBL	1021	1069	N/A
				LUCL	1123	1171	N/A
				LSL	1233	1281	N/A
Armchair	18.3 lbs			COM	1023	1071	1411
		768	816	1	1054	1102	1507
				2	1088	1136	1605
				3	1113	1161	1682
				4	1155	1203	1810
				5	1198	1246	1933
				COL	1134	1182	N/A
				LUBL	1155	1203	N/A
				LUCL	1257	1305	N/A
				LSL	1367	1415	N/A

Price List 2024 - USD excl. sales tax - Version 1.1

Soft lane castors 21 \$



SixE Learn

By PearsonLloyd

No matter how you look at SixE, it presents itself as a perfectly bold move – bending the rules of how comfortable a simple polypropylene shell chair can be.

- 10* year warranty
- Design for Disassembly
- Chair for active learning environments, classrooms and higher education
- GreenTag^{Cert™}



Standard frame colours: ● B10 BAIN - HOWE Grey	POLYPROPYLENE (EPO/EPP)		UPHOLSTERY			
	PP200 ● RECYCLED PP200 ●	PP100 ● PP300 ○ PP310 ● PP270 ● PP120 ● PP340 ● PP350 ● RECYCLED PP100 ● RECYCLED PP300 ○ RECYCLED PP120 ●	GROUP	SEAT UPH.		FULLY UPH. (EFQ/ EFR)
				BLACK (EFO/ EFP)	COLOUR (EFO/ EFP)	
	\$	\$		\$	\$	\$
Learn side chair  25.8 lbs 660 - 780 mm 26" - 30.7" 395 - 515 mm 15.6" - 20.3" 720 mm 28.3"	1127	1167	COM	1421	1461	1770
			1	1452	1492	1866
			2	1486	1526	1964
			3	1511	1551	2041
			4	1553	1593	2169
			5	1596	1636	2292
			COL	1532	1572	N/A
			LUBL	1553	1593	N/A
			LUCL	1655	1695	N/A
			LSL	1765	1805	N/A
Learn armchair  28 lbs 660 - 780 mm 26" - 30.7" 395 - 515 mm 15.6" - 20.3" 720 mm 28.3"	1252	1300	COM	1555	1603	1893
			1	1586	1634	1989
			2	1620	1668	2087
			3	1645	1693	2164
			4	1687	1735	2292
			5	1730	1778	2415
			COL	1666	1714	N/A
			LUBL	1687	1735	N/A
			LUCL	1789	1837	N/A
			LSL	1899	1947	N/A

Price List 2024 - USD excl. sales tax - Version 1.1

Soft lane castors	21	\$
Bag hook	52	\$
Cupholder	46	\$

MN1 cantilever

By Morten Nikolajsen

Whenever comfort, classic lines, and functionality are vital, the MN1 chair is the obvious choice.

- 5 year warranty
- Stacks 5 chairs
- FSC certified
- Design for Disassembly



Standard base finish is chrome Black base and armrests as an option Standard armrests is polished aluminium	GROUP	MESH (KELCC/KELCD)		FULLY UPH. (KYLCC/KYLCD)		Black base w. or w/o black armrests	Armrest pad with chrome or black base	
		V3	LW25 LW17	V3	LW25 LW17		Uph. armrests	Veneer armrests
		Back frame	Back frame	Back frame	Back frame			
		Oak	Black or walnut stained	Oak	Black or walnut stained			
		\$	\$	\$	\$	\$	\$	\$
Side chair, normal back (A) 19.8 lbs 		COM	1379	1467	1548	1636		
		1	1406	1494	1631	1719		
		2	1437	1525	1715	1803		
		3	1467	1555	1815	1903		
		4	1531	1619	2001	2089		
		5	1552	1640	2064	2152	+46	+N/A
		COL	1508	1596	1934	2022		
		LUBL	1531	1619	2001	2089		
		LUCL	1684	1772	2460	2548		
		LSL	1867	1955	N/A	3099		
Side chair, high back (B) 20.7 lbs 		COM	1515	1603	1682	1770		
		1	1542	1630	1765	1853		
		2	1573	1661	1849	1937		
		3	1603	1691	1949	2037		
		4	1667	1755	2135	2223		
		5	1688	1776	2198	2286	+46	+N/A
		COL	1644	1732	2068	2156		
		LUBL	1667	1755	2135	2223		
		LUCL	1820	1908	2594	2682		
		LSL	N/A	2091	3145	3233		
Armchair, normal back (A) 20.9 lbs 		COM	1510	1598	1548	1767		
		1	1537	1625	1762	1850		
		2	1568	1656	1846	1934		
		3	1598	1686	1946	2034		
		4	1662	1750	2132	2220		
		5	1683	1771	2195	2283	+90	+303
		COL	1639	1727	2065	2153		
		LUBL	1662	1750	2132	2220		
		LUCL	1815	1903	2591	2679		
		LSL	1998	2086	3142	3230		
Armchair, high back (B) 21.8 lbs 		COM	1646	1734	1813	1901		
		1	1673	1761	1896	1984		
		2	1704	1792	1980	2068		
		3	1734	1822	2080	2168		
		4	1798	1886	2266	2354		
		5	1819	1907	2329	2417	+90	+303
		COL	1775	1863	2199	2287		
		LUBL	1798	1886	2266	2354		
		LUCL	1951	2039	2725	2813		
		LSL	2134	2222	3276	3364		

Price list 2024 - USD excl. V.A.T. - Version 1.1

Felt glides 42 \$

MN1 X-base

By Morten Nikolajsen

Whenever comfort, classic lines, and functionality are vital, the MN1 chair is the obvious choice.

- 5 year warranty
- Simple and elegant aesthetics
- Design for Disassembly
- Height adjustable
- FSC certified



Black base and armrests as an option Standard base and armrests is polished aluminium	GROUP	MESH (KEM)		FULLY UPH. (KYM)		Black base w. or w/o black armrests	Armrest pad with chrome or black base	
		V3	LW25 LW17	V3	LW25 LW17		Upth. armrests	Veneer armrests
		Back frame	Back frame	Back frame	Back frame			
		Oak	Black or walnut stained	Oak	Black or walnut stained			
		\$	\$	\$	\$	\$	\$	\$
Side chair, normal back (A) 23.1 lbs 	COM 1642 1730 1803 1891 1 1669 1757 1886 1974 2 1700 1788 1970 2058 3 1730 1818 2070 2158 4 1792 1880 2256 2344 5 1815 1903 2319 2407 COL 1773 1861 2189 2277 LUBL 1792 1880 2256 2344 LUCL 1947 2035 2715 2803 LSL 2130 2218 3266 3354					+46	+N/A	+N/A
Side chair, high back (B) 24 lbs 	COM 1778 1866 1937 2025 1 1805 1893 2020 2108 2 1836 1924 2104 2192 3 1866 1954 2204 2292 4 1928 2016 2390 2478 5 1951 2039 2453 2541 COL 1909 1997 2323 2411 LUBL 1928 2016 2390 2478 LUCL 2083 2171 2849 2937 LSL 2266 2354 3400 3488					+46	+N/A	+N/A
Armchair, normal back (A) 24.3 lbs 	COM 1725 1813 1849 1937 1 1752 1840 1932 2020 2 1783 1871 2016 2104 3 1813 1901 2116 2204 4 1875 1963 2302 2390 5 1898 1986 2365 2453 COL 1856 1944 2235 2323 LUBL 1875 1963 2302 2390 LUCL 2030 2118 2761 2849 LSL 2213 2301 3312 3400					+90	+303	+204
Armchair, high back (B) 25.1 lbs 	COM 1861 1949 1983 2071 1 1888 1976 2066 2154 2 1919 2007 2150 2238 3 1949 2037 2250 2338 4 2011 2099 2436 2524 5 2034 2122 2499 2587 COL 1992 2080 2369 2457 LUBL 2011 2099 2436 2524 LUCL 2166 2254 2895 2983 LSL 2349 2437 3446 3534					+90	+303	+204

Price list 2024 - USD excl. V.A.T. - Version 1.1

Fixed with return swivel	61	\$
Felt glides	42	\$

MN1 5-star

By Morten Nikolajsen

Whenever comfort, classic lines, and functionality are vital, the MN1 chair is the obvious choice.

- 5 year warranty
- Simple and elegant aesthetics
- Design for Disassembly
- Height adjustable
- FSC certified



Standard base is polished aluminium with black castors.
Black base and armrests as an option
Standard armrest is polished aluminium

B51 B7

Side chair, normal back (A) 23.6 lbs
Side chair, high back (B) 24.5 lbs
Armchair, normal back (A) 24.7 lbs
Armchair, high back (B) 25.6 lbs

GROUP	MESH (KENLA/KENLB)		FULLY UPH. (KENLA/KENLB)		Black base w. or w/o black armrests	Armrest pad with chrome or black base	
	V3	LW25	V3	LW25		Uph. armrests	Veneer armrests
	Back fraHe	Back fraHe	Back fraHe	Back fraHe			
	Oak	Black or walnut stained	Oak	Black or walnut stained	\$	\$	\$
	\$	\$	\$	\$			
COM	1824	1912	1978	2066	+46	+N/A	+N/A
1	1851	1939	2061	2149			
2	1882	1970	2147	2235			
3	1912	2000	2245	2333			
4	1976	2064	2433	2521			
5	1997	2085	2494	2582			
COL	1953	2041	2364	2452			
LUBL	1976	2064	2433	2521			
LUCL	2129	2217	2890	2978			
LSL	2312	2400	3443	3531			
COM	1960	2048	2114	2202	+46	+N/A	+N/A
1	1987	2075	2197	2285			
2	2018	2106	2283	2371			
3	2048	2136	2381	2469			
4	2112	2200	2569	2657			
5	2133	2221	2630	2718			
COL	2089	2177	2500	2588			
LUBL	2112	2200	2569	2657			
LUCL	2265	2353	3026	3114			
LSL	2448	2536	3579	3667			
COM	1907	1995	2032	2120	+90	+303	+204
1	1934	2022	2115	2203			
2	1965	2053	2201	2289			
3	1995	2083	2299	2387			
4	2059	2147	2487	2575			
5	2080	2168	2548	2636			
COL	2036	2124	2418	2506			
LUBL	2059	2147	2487	2575			
LUCL	2212	2300	2944	3032			
LSL	2395	2483	3497	3585			
COM	2043	2131	2168	2256	+90	+303	+204
1	2070	2158	2251	2339			
2	2101	2189	2337	2425			
3	2131	2219	2435	2523			
4	2195	2283	2623	2711			
5	2216	2304	2684	2772			
COL	2172	2260	2554	2642			
LUBL	2195	2283	2623	2711			
LUCL	2348	2436	3080	3168			
LSL	2531	2619	3633	3721			

Price list 2024 - USD excl. V.A.T. - Version 1.1

Soft lane castors 42 \$

AS100

By Andreas Störko

The AS series is highly inspired and highly functional. Combining elegance and utility with true mobility, the family of nesting chairs and tables leaves room for all imaginable purposes.

- 10 year warranty
- Lightweight and space-saving
- Easy to link multiple chairs for relocation
- Castors are weight activated brake castors
- Stacks horizontally as many chairs as wanted
- Return swivel mechanism with 4 positions



STANDARD ARMRESTS, SEATBAR AND BASE COLOURS



GROUP FULLY UPHOLSTERED (DU)

Side chair (CCS)

22 lbs

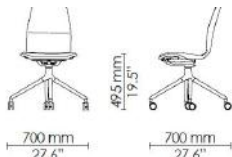

Armchair (CCA)

24 lbs

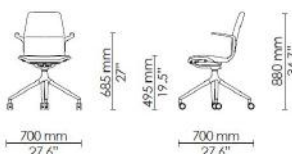

	\$
COM	1537
1	1607
2	1677
3	1760
4	1887
5	1967
COL	1835
LUBL	1887
LUCL	2239
LSL	2666
COM	1666
1	1736
2	1806
3	1889
4	2016
5	2096
COL	1964
LUBL	2016
LUCL	2368
LSL	2795

Price List 2025 - USD excl. sales tax - Version 1.0

Soft castors for hard floors 20 \$

Accessories

40/4 Writing tablet

Most people see the 40/4 as a pioneering design that has stood the test of time. We like to think of it as a legacy that continues to move you in new ways.

All accessories are recommended for chrome frames only.



Writing tablet without or with cupholder		No.	Per Piece
Writing tablet without cupholder 40/4 writing tablet, chrome frame, 0.4" compact laminate Left and right version is available			
No Cupholder	Black	DAZS	329
No Cupholder	White	DAZS	329
Cupholder	Black	DAZS_Y	372
Cupholder	White	DAZS_Y	372
40/4 and SixE Transporter for writing tablets			
Writing tablet dolly, up to 18 pcs. Dolly with 3 boxes, length: 16", depth: 24", height: 55".			Per Transporter
Writing tablet dolly, up to 36 pcs. Double dolly with 6 boxes, length: 32", depth: 24", height: 55".			\$
18 Pcs	3 boxes	404WTDLY01	1001
36 pcs	6 boxes	404WTDLY02	2002



Price List 2024 - USD excl. sales tax - Version 1.1







Accessories

40/4 Linking

Most people see the 40/4 as a pioneering design that has stood the test of time. We like to think of it as a legacy that continues to move you in new ways.

All accessories are recommended for chrome frames only.



LD linking	No.	Per Piece		
Width between seats: 2.6". Linking side chair to side chair; allows to link chairs in a straight line.		\$		
40/4 linking device LD1H in chrome	404ACCLD1H	57		
Width between seats: 4.9" Linking: side chair to side chair; side chair to armchair; allows to link chairs in a straight line.				
40/4 linking device LD2H in chrome	404ACCLD2H	72		
Width between seats: 7.3" Linking: side chair to side chair; side chair to armchair; armchair to armchair; allows to link chairs in a straight line.				
40/4 linking device LD3H in chrome	404ACCLD3H	79		
Width between seats: 3.2" Linking side chair to side chair; allows to form the arc of chairs; the radius is adjustable, 0-12 degrees.				
40/4 radius linking device LD2RL in chrome	404ACCLD2RL	86		
Width between seats: 7.9" Linking armchairs with writing tablets to armchairs with writing tablets; allows to link chairs in a straight line.				
40/4 linking device LD4S in chrome	404ACCLD4S	100		
Width between seats: 2.75" Linking side chair to side chair; allows to link chairs in a straight line. Recommended for public spaces where EN 14703 is a requirement.				
40/4 safety linking device LD5S in chrome	404ACCLD5S	86		

Price List 2024 - USD excl. sales tax - Version 1.1



Accessories

40/4 Dolly and Glides

Most people see the 40/4 as a pioneering design that has stood the test of time. We like to think of it as a legacy that continues to move you in new ways.

All accessories are recommended for chrome frames only.



Dollies			No.	Per Piece	
All accessories recommended for chrome frames only. Dollies suit side chairs and arm chairs in polyamide, veneer, or full upholstery. For dollies to other versions of the 40/4 chair - please ask HOWE				\$	
Hook/eye, fin linking or without linking			DLYSSAASF10	875	
Brace linking			DLYSSBCSF10	875	
Extra glides with felt				Per Piece	
				\$	
For hook/eye and fin-linking chairs on chrome frames					
Transparent female glides with felt with screws			02328WS	7	
Transparent male glides with felt with screws			02329WS	7	
Transparent regular glides with felt with pin			02352	7	
For non-linking chairs; for linking armchairs and for brace-linking side chairs					
Transparent regular glides with felt with pin			02352	7	
For bar chairs					
Transparent bar glides with felt for both chrome and painted frames			17330	7	
Extra glides without felt				Per Piece	
				\$	
For hook/eye and fin-linking chairs on chrome frames					
Transparent female glides without felt with screws			02325WS	6	
Transparent male glides without felt with screws			02326WS	6	
Transparent regular glides without felt with pin			02351	6	
For non-linking chairs; for linking armchairs and for brace-linking side chairs					
Transparent regular glides without felt with pin			02351	6	
For bar chairs					
Transparent bar glides with felt for both chrome and painted frames			17327	6	

Price List 2024 - USD excl. sales tax - Version 1.1

Accessories

40/4 Linking items and book holders

Most people see the 40/4 as a pioneering design that has stood the test of time. We like to think of it as a legacy that continues to move you in new ways.

All accessories are recommended for chrome frames only.



LD linking continued		No.	Per Piece	
Width between seats: 2.75" Linking side chair to side chair; allows to link chairs in a straight line. Recommended for public spaces where EN 14703 is a requirement.			\$	
40/4 safety linking device LD55	404ACCLD55	86		
Cup holder for 40/4 safety linking device LD55	404ACCLD55 CUP	11		
Numbering for 40/4 safety linking device LD55	404ACCLD55 NUM	11		
Linking tool				
40/4 Linking tool In chrome. An aid to the linking/unlinking operation of side chairs with integrated linking.				
Linking tool (for side chairs with integrated linking)	404ACC0300 101	72		
Row spacer bar In HOWE grey powdercoating with rubber lock, allows a 13.78" aisle between rows.				
Row spacer bar for armchairs, 13.78" distance between the rows	404ACC027A 350	93		
Row spacer bar for side chairs, 13.78" distance between the rows	04ACC027S35	93		
Bookholders				
40/4 book rack in chrome				
Book rack (for side chairs and armchairs)	404ACC0290 101	172		
Hymn book holder In chrome, 4.72" high and 6.89" long; 6.1" wide (distance between front legs of chairs) with integrated linking. Note! Hymn book holder does not work with the writing tablet.				
Hymn book holder (for side chairs and armchairs, non-linking)	404ACC0280 101	100		

Accessories

40/4 Numbering tag

Most people see the 40/4 as a pioneering design that has stood the test of time. We like to think of it as a legacy that continues to move you in new ways.

All accessories are recommended for chrome frames only.



Numbering tags for row and seat	
The price of one numbering tag. The start-up fee is 450 \$	
40/4 Row/seat numbering tag	

No.	Per Piece
	\$
404SN1120	57

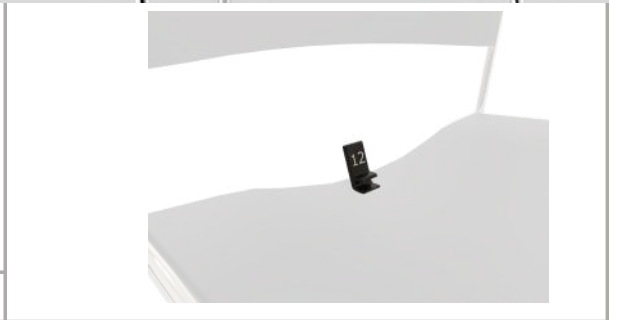

Price List 2024 - USD excl. sales tax - Version 1.1



Accessories

SixE Writing tablet and Dolly

No matter how you look at SixE, it presents itself as a perfectly bold move – bending the rules of how comfortable a simple polypropylene shell chair can be.

All accessories are recommended for chrome frames only.



Writing tablet without or with cupholder		No.	Per Piece	
Writing tablet without cupholder SixE writing tablet, chrome frame, 0.4" compact laminate Left and right version is available			\$	
No Cupholder	Black	EAZS	343	
No Cupholder	White	EAZS	343	
Cupholder	Black	EAZS_Y	386	
Cupholder	White	EAZS_Y	386	
40/4 and SixE Transporter for writing tablets				
Writing tablet dolly, up to 18 pcs. Dolly with 3 boxes, length: 16", depth: 24", height: 55"			Per Transporter	
Writing tablet dolly, up to 36 pcs. Double dolly with 6 boxes, length: 32", depth: 24", height: 55"			\$	
18 Pcs	3 boxes	404WTDLY01	1001	
36 pcs	6 boxes	404WTDLY02	2002	
Dolly for SixE 4-leg and sled				
Single HOWE grey dolly with multidirectional castors Accommodates up to 25 chairs.			Per Dolly	
			\$	
25 chairs		22920010	1373	

Price List 2024 - USD excl. sales tax - Version 1.1

Accessories

MN1 Dolly

Whenever comfort, classic lines, and functionality are vital, the MN1 chair is the obvious choice.

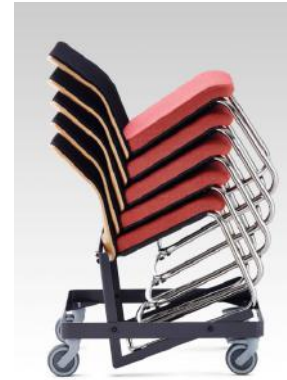

Dolly	No.	Per Piece
Dolly for MN1 chairs with cantilever base Capacity of 5 chairs, HOWE grey coated.		\$
Dolly	MN1DLYSS1B F10	958

Price List 2024 - USD excl. sales tax - Version 1.1

Notes for chairs

Price list 2024 - USD excl. V.A.T. - Version 1.1

General

HOWE Standard delivery time within North America is determined on a case-to-case basis – please contact Customer Service for details.

In case of large quantities and/or customized products delivery time is usually longer than for standard products.

For chairs with upholstery, the lead time starts being counted once fabric reaches the production line.

We recommend linking only for chrome frames.

Frame colours from RAL K5 or K7 colour card are available. For quantities < 200 chairs the colour fee is 520 USD per RAL colour. For quantities ≥ 200 chairs there is no fee. Visual impressions of particular RAL may differ on various surfaces. Preparing product's sample(s) is compulsory. Lead time to be confirmed by HOWE CS.

Stained veneer is possible with RAL colours from RAL K5 or K7 colour card. For quantities < 200 chairs the colour fee is 520 USD per RAL colour. For quantities ≥ 200 chairs there is no fee. Visual impression of particular RAL may differ on various surfaces. Preparing product's sample(s) is compulsory. Lead time to be confirmed by HOWE CS.

We recommend only stacking chairs with chrome frame.

Veneer is a natural material - differences in structure and colour may occur.

Upholstered armrests are as standard in the same fabric/leather type and colour as the seat and the back.

Soft castors are recommended for hard floors, hard castors for soft floors.

40/4

Table surface protection protects the table surface when the chairs are hung up; it may be used only for non-linking chairs.

Please be aware that extra glides are not available for wooden frames.

40/4 can be stacked on a single, double, triple or quarto dolly. Double, triple and quarto can only be used with hook/eye linking.

As standard chair top frame and its swivel base are of the same colour but be aware that they are always matched by the chrome gas lift.

Glides for linking side chairs; the whole set for one linking side chair comprises of one male glide and one female glide at the front part of the frame (reinforcing the linking in the front part of the chair frame) plus two regular glides at the rear part of the frame; whether these are glides with or without felt depends only on customer's needs.

Regular glides are suitable for non-linking side chairs, for all types of armchairs and for lounge chairs; the whole set comprises of four clear regular glides per chair.

Glides for barstool with both chrome and painted frames; the whole set comprises of four regular glides per chair.

MN1

Fixed seating height - there is no possibility to install both height adjustable and return mechanism together.

Gas lift is black for black base and chrome for polished aluminium base.

SixE

Bag hook is recommended only for polypropylene backs.

FABRICS

Enhance your designs with consciously chosen fabrics of top-notch performance and sustainable profiles. If you're seeking a solution that goes beyond standard options, please contact HOWE Customer Service.

40/4
MNI
SixE
AS100



62126

CURA by Gabriel

EMEA + US/CAN price group 1

Composition: 98% post-consumer recycled polyester, 2% polyester
Martindale: 100.000
Washable: 60-74°C
Cleanable: YES

Flammability CAL 117: YES
Added flame retardant: NO
Flammability M: NO
Crib 5: NO
Ecolabel: YES
Oeko-Tex: YES

[VIEW FULL COLOR RANGE](#)

40/4
MNI
SixE
AS100



64030

EVENT by Gabriel

EMEA + US/CAN price group 1

Composition: 100% polyester
Martindale: 100.000
Washable: 60°C
Cleanable: YES

Flammability CAL 117: YES
Added flame retardant: NO
Flammability M: NO
Crib 5: NO
Ecolabel: YES
Oeko-Tex: YES

[VIEW FULL COLOR RANGE](#)

40/4
MNI



61095

SixE
AS100
Needs testing

FIGHTER by Gabriel

EMEA + US/CAN price group 1

Composition: 100% recyclable polyester
Martindale: 130.000
Washable: YES
Cleanable: Only dry

Flammability CAL 117: YES
Added flame retardant: NO
Flammability M: NO
Crib 5: NO
Ecolabel: NO
Oeko-Tex: YES

[VIEW FULL COLOR RANGE](#)

40/4
MNI
SixE
AS100



Wedgwood - IF027

MAIN LINE PLUS by Camira

EMEA + US/CAN price group 1

Composition: 67% wool, 20% flame retardant viscose, 13% viscose
Martindale: ≥50,000
Washable: YES
Cleanable: YES

Flammability CAL 117: YES
Added flame retardant: YES
Flammability M: NO
Crib 5: YES
Ecolabel: NO
Oeko-Tex: YES

[VIEW FULL COLOR RANGE](#)

40/4
MNI
SixE

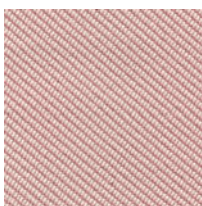

Seafarer - OOC16





OCEANIC by Camira

EMEA + US/CAN price group 1

Composition: 100% post-consumer recycled polyester
Martindale: ≥100,000
Washable: 60°C
Cleanable: YES

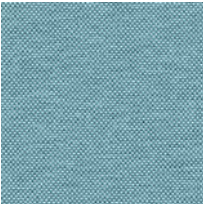
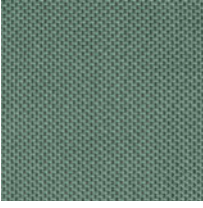
Flammability CAL 117: YES
Added flame retardant: NO
Flammability M: NO
Crib 5: NO
Ecolabel: YES
Oeko-Tex: YES

[VIEW FULL COLOR RANGE](#)

<p>40/4 MN1 SixE</p>	 <p>Tide - QUE12</p>	<p>QUEST by Camira</p> <hr/> <p>Composition: 100% post-consumer recycled polyester</p> <p>Martindale: ≥100,000</p> <p>Washable: 60°C</p> <p>Cleanable: YES</p>	<p>Flammability CAL 117: YES</p> <p>Added flame retardant: NO</p> <p>Flammability M: NO</p> <p>Crib 5: NO</p> <p>Ecolabel: YES</p> <p>Oeko-Tex: YES</p>	<p>EMEA + US/CAN price group 1</p> <hr/> <p style="text-align: center; background-color: #e0e0e0; padding: 2px;">VIEW FULL COLOR RANGE</p>
<p>40/4 MN1 SixE AS100</p>	 <p>Joy - REP07</p>	<p>REPLAY by Camira</p> <hr/> <p>Composition: 100% post-consumer recycled flame retardant polyester</p> <p>Martindale: ≥100,000</p> <p>Washable: 60°C</p> <p>Cleanable: YES</p>	<p>Flammability CAL 117: NO</p> <p>Added flame retardant: YES</p> <p>Flammability M: M1</p> <p>Crib 5: NO</p> <p>Ecolabel: YES</p> <p>Oeko-Tex: YES</p>	<p>EMEA + US/CAN price group 1</p> <hr/> <p style="text-align: center; background-color: #e0e0e0; padding: 2px;">VIEW FULL COLOR RANGE</p>
<p>40/4 MN1 SixE</p>	 <p>Resin - EGL04</p>	<p>RIVET by Camira</p> <hr/> <p>Composition: 100% post-consumer recycled polyester</p> <p>Martindale: ≥80,000</p> <p>Washable: 60°C</p> <p>Cleanable: YES</p>	<p>Flammability CAL 117: YES</p> <p>Added flame retardant: NO</p> <p>Flammability M: NO</p> <p>Crib 5: NO</p> <p>Ecolabel: YES</p> <p>Oeko-Tex: NO</p>	<p>EMEA + US/CAN price group 1</p> <hr/> <p style="text-align: center; background-color: #e0e0e0; padding: 2px;">VIEW FULL COLOR RANGE</p>
<p>40/4 MN1 SixE</p>	 <p>66763</p>	<p>STEP by Gabriel</p> <hr/> <p>Composition: 100% Trevira CS</p> <p>Martindale: 100.000</p> <p>Washable: 60-74°C</p> <p>Cleanable: YES</p>	<p>Flammability CAL 117: YES</p> <p>Added flame retardant: YES</p> <p>Flammability M: M1</p> <p>Crib 5: YES</p> <p>Ecolabel: YES</p> <p>Oeko-Tex: YES</p>	<p>EMEA + US/CAN price group 1</p> <hr/> <p style="text-align: center; background-color: #e0e0e0; padding: 2px;">VIEW FULL COLOR RANGE</p>
<p>40/4 MN1 SixE AS100</p>	 <p>63138</p>	<p>STEP MELANGE by Gabriel</p> <hr/> <p>Composition: 100% Trevira CS</p> <p>Martindale: 100.000</p> <p>Washable: 60-74°C</p> <p>Cleanable: YES</p>	<p>Flammability CAL 117: YES</p> <p>Added flame retardant: YES</p> <p>Flammability M: M1</p> <p>Crib 5: YES</p> <p>Ecolabel: YES</p> <p>Oeko-Tex: YES</p>	<p>EMEA + US/CAN price group 1</p> <hr/> <p style="text-align: center; background-color: #e0e0e0; padding: 2px;">VIEW FULL COLOR RANGE</p>
<p>40/4 MN1 SixE AS100</p>	 <p>Atacama - TAN-0004</p>	<p>TANNERY by Spradling</p> <hr/> <p>Composition: Vinyl topcoat, cotton backing</p> <p>Martindale: >100.000</p> <p>Washable: NO</p> <p>Cleanable: YES</p>	<p>Flammability CAL 117: YES</p> <p>Added flame retardant: YES</p> <p>Flammability M: M2</p> <p>Crib 5: NO</p> <p>Ecolabel: NO</p> <p>Oeko-Tex: NO</p>	<p>EMEA + US/CAN price group 1</p> <hr/> <p style="text-align: center; background-color: #e0e0e0; padding: 2px;">VIEW FULL COLOR RANGE</p>

40/4
MNI
SixE

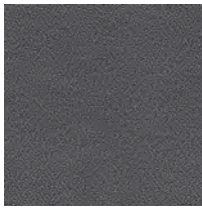

Blizzard - YS081

XTREME by Camira

EMEA + US/CAN price group 1

Composition: 100% post-consumer recycled flame retardant polyester
 Martindale: ≥100,000
 Washable: 60°C
 Cleanable: YES

Flammability CAL 117: YES
 Added flame retardant: YES
 Flammability M: NO
 Crib 5: YES
 Ecolabel: YES
 Oeko-Tex: YES

[VIEW FULL COLOR RANGE](#)

40/4
MNI
SixE
AS100



Tooting - MLF7

MAIN LINE FLAX by Camira

EMEA + US/CAN price group 2

Composition: 70% virgin wool, 30% flax
 Martindale: ≥50,000
 Washable: NO
 Cleanable: YES

Flammability CAL 117: YES
 Added flame retardant: NO
 Flammability M: NO
 Crib 5: YES
 Ecolabel: YES
 Oeko-Tex: NO

[VIEW FULL COLOR RANGE](#)

40/4
MNI
SixE



Warrior - 466553-045

METAPHOR by Maharam

EMEA + US/CAN price group 2

Composition: 100% polyester
 Martindale: 100,000 double rubs Wyzenbeek
 Washable: NO
 Cleanable: YES

Flammability CAL 117: YES
 Added flame retardant: NO
 Flammability M: NO
 Crib 5: NO
 Ecolabel: NO
 Oeko-Tex: NO

[VIEW FULL COLOR RANGE](#)

40/4
MNI



Skylight

VALENCIA B1 by Spradling

EMEA + US/CAN price group 2

Composition: Vinyl topcoat, cotton backing
 Martindale: >300.000
 Washable: NO
 Cleanable: YES

Flammability CAL 117: YES
 Added flame retardant: YES
 Flammability M: M1
 Crib 5: YES
 Ecolabel: NO
 Oeko-Tex: NO

[VIEW FULL COLOR RANGE](#)

40/4
MNI
SixE
AS100



04031

CRISP by Gabriel

EMEA + US/CAN price group 3

Composition: 93% wool, 7% polyamide
 Martindale: 200 000
 Washable: NO
 Cleanable: YES

Flammability CAL 117: YES
 Added flame retardant: NO
 Flammability M: M1
 Crib 5: NO
 Ecolabel: YES
 Oeko-Tex: YES

[VIEW FULL COLOR RANGE](#)

40/4
MNI
SixE
AS100



64119

FAME by Gabriel

EMEA + US/CAN price group 3

Composition: 95% wool, 5% polyamide
 Martindale: 200 000
 Washable: NO
 Cleanable: Only dry

Flammability CAL 117: YES
 Added flame retardant: NO
 Flammability M: NO
 Crib 5: YES
 Ecolabel: YES
 Oeko-Tex: YES

[VIEW FULL COLOR RANGE](#)

40/4
MNI
SixE
AS100

0682

REMIX 3 by Kvadrat

EMEA + US/CAN price group 3

Composition: 90% new wool, 10% nylon
 Martindale: 100,000
 Washable: NO
 Cleanable: Only dry

Flammability CAL 117: YES
 Added flame retardant: NO
 Flammability M: NO
 Crib 5: NO
 Ecolabel: YES
 Oeko-Tex: NO

[VIEW FULL COLOR RANGE](#)
40/4
MNI
AS100

0926

CANVAS 2 by Kvadrat

EMEA + US/CAN price group 4

Composition: 90% new wool, 10% nylon
 Martindale: 100,000
 Washable: NO
 Cleanable: Only dry

Flammability CAL 117: YES
 Added flame retardant: NO
 Flammability M: NO
 Crib 5: NO
 Ecolabel: YES
 Oeko-Tex: NO

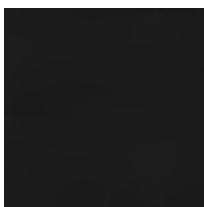
[VIEW FULL COLOR RANGE](#)
40/4
MNI
AS100

Black - 41599

ULTRA by Sørensen Leather

EMEA + US/CAN price group 4

(TANGO), BLACK

Composition: Protected
 Martindale: -
 Washable: -
 Cleanable: -

Flammability CAL 117: YES
 Added flame retardant: NO
 Flammability M: -
 Crib 5: -
 Ecolabel: -
 Oeko-Tex: -

[BLACK ONLY](#)

AS100

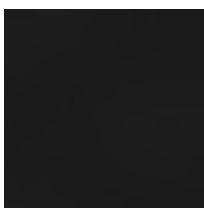

Black - 42438

BASIC by Sørensen Leather

EMEA + US/CAN price group 5

(KNIGHT), BLACK40/4
MNI
Needs
testing

Composition: Protected
 Martindale: -
 Washable: -
 Cleanable: -

Flammability CAL 117: YES
 Added flame retardant: NO
 Flammability M: -
 Crib 5: -
 Ecolabel: -
 Oeko-Tex: YES

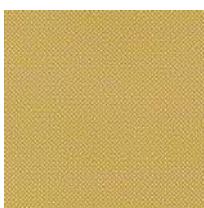
[BLACK ONLY](#)
40/4
MNI
SixE
AS100

0407

HALLINGDAL 65 by Kvadrat

EMEA + US/CAN price group 5

Composition: 70% new wool,
30% viscose
 Martindale: 100.000
 Washable: NO
 Cleanable: Only dry

Flammability CAL 117: YES
 Added flame retardant: NO
 Flammability M: NO
 Crib 5: YES
 Ecolabel: YES
 Oeko-Tex: NO

[VIEW FULL COLOR RANGE](#)
40/4
MNI
SixE
AS100

0865

STEELCUT TRIO 3 by Kvadrat

EMEA + US/CAN price group 5

Composition: 90% new wool, 10% nylon
 Martindale: 100.000
 Washable: NO
 Cleanable: Only dry

Flammability CAL 117: YES
 Added flame retardant: NO
 Flammability M: NO
 Crib 5: NO
 Ecolabel: YES
 Oeko-Tex: NO

[VIEW FULL COLOR RANGE](#)

40/4
MNI
AS100

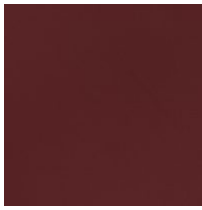

Burgundy - 30317

SAVANNE by Sørensen Leather

EMEA + US/CAN price group LSL

Composition: Semi-aniline
Martindale: -
Washable: -
Cleanable: -

Flammability CAL 117: -
Added flame retardant: -
Flammability M: -
Crib 5: -
Ecolabel: -
Oeko-Tex: YES

[VIEW FULL COLOR RANGE](#)

40/4
MNI
AS100



Altweiss - 41576

ULTRA by Sørensen Leather

EMEA + US/CAN price group LUCL

(TANGO), COLOURED

Composition: Protected
Martindale: -
Washable: -
Cleanable: -

Flammability CAL 117: -
Added flame retardant: -
Flammability M: -
Crib 5: -
Ecolabel: -
Oeko-Tex: -

[VIEW FULL COLOR RANGE](#)



Moveo Training

By Justus Kolberg & Erik Simonsen

Easy to move thanks to a light frame, Moveo is even more flexible than your calendar. Optimum mobility is ensured by the perfectly designed wheels.

- 10 year warranty
- GreenTag^{Cert™}
- C-leg style
- Flip top table system



	Laminate (MBB)	Veneer (MBC)	Stained veneer (MBC)	
Laminate is with matching ABS edge. Veneer is with matching hardwood edge. Table top thickness is 1" <div style="display: flex; justify-content: space-around; align-items: center;"> ● ● ● </div> B6 B51 B52 Standard frame* with castors with breaks *Other frame colours - see the notes	LU45 ● LU31 ● LU35 ● LU300 ● LU400 ● LU200 ●	VU1 ● VU3 ● VU5 ● VU15 ●	LW17 ● LW25 ● LW30 ●	Linking
Rectangular 48"x24" (321L)	2590	3237	3741	304
Rectangular 60"x24" (342D)	2731	3414	3918	
Rectangular 60"x30" (441O)	2795	3493	3997	
Rectangular 72"x24" (362E)	2809	3511	4015	
V-shape 48"x24" (222F)	2701	3376	3880	304
V-shape 60"x30" (442C)	2809	3511	4015	

Price List 2024 - USD excl. sales tax - Version 1.1

Moveo Training - custom size ranges

Rough, reference information - please verify custom sizes with CS, especially for non-rectangular tabletops

Rectangle: length 28"-100" | width 18"-36"





















Moveo Meeting

By Justus Kolberg & Erik Simonsen

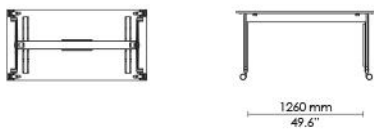
Easy to move thanks to a light frame, Moveo is even more flexible than your calendar. Optimum mobility is ensured by the perfectly designed wheels.

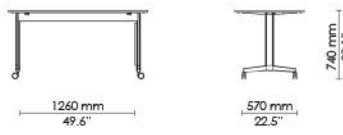
- 10 year warranty
- GreenTag^{Cert™}
- Inverted T-leg style
- Flip top table system

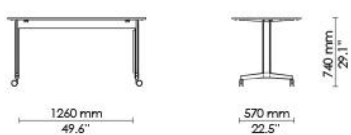

	Laminate (MTB)	Veneer (MTC)	Stained veneer (MTC)		
<p>Laminate is with matching ABS edge. Veneer is with matching hardwood edge.</p> <p>Table top thickness is 1"</p> <p> B6 B51 B52</p> <p>Standard frame* with castors with breaks *Other frame colours - see the notes</p>	<p>LU45 </p> <p>LU31 </p> <p>LU35 </p> <p>LU300 </p> <p>LU400 </p> <p>LU200 </p>	<p>VU1 </p> <p>VU3 </p> <p>VU5 </p> <p>VU15 </p>	<p>LW17 </p> <p>LW25 </p> <p>LW30 </p>	Linking	
	\$	\$	\$	\$	
  	<p>Rectangular 60"x30" (241O)</p>	2798	3498	4002	304
<p>Rectangular 72"x36" (461R)</p>	3012	3765	4269		
  	<p>Half-round 60"x30" (121E)</p>	2897	3621	4125	152
  	<p>V-Shape 60"x30" (342C)</p>	2811	3514	4018	N/A

Price List 2024 - USD excl. sales tax - Version 1.1

Moveo Meeting - custom size ranges

Rough, reference information - please verify custom sizes with CS, especially for non-rectangular tabletops
Rectangle: length 28"-100" | width 24"-36"

Moveo Conference modular

By Justus Kolberg & Erik Simonsen

Easy to move thanks to a light frame, Moveo is even more flexible than your calendar. Optimum mobility is ensured by the perfectly designed wheels.

- 10 year warranty
- GreenTag^{Cert™}
- Flip top table system



	Laminate (MVB)	Veneer (MVC)	Stained veneer (MVC)		
Laminate is with matching ABS edge. Veneer is with matching hardwood edge.	LU45 LU31 LU35 LU300 LU400 LU200	VU1 VU3 VU5 VU15	LW17 LW25 LW30	Linking	
Table top thickness is 1" B6 B51 B52 Standard frame* with castors with breaks *Other frame colours - see the notes	\$	\$	\$		\$
Rectangular	88"x40" (485M)	5734	7168	8176	304
Rectangular	88"x48" (485N)	6697	8372	9380	
Half-Boat	96"x42" (786A)	6627	8284	9292	152
Half-Boat	96"x48" (786B)	7353	9192	10200	

Price List 2024 - USD excl. sales tax - Version 1.1

Moveo Conference, Modular - custom size ranges

Rough, reference information - please verify custom sizes with CS, especially for non-rectangular tabletops
Rectangle: length 28"-86" | width 36"-48"

Moveo Conference stand alone

By Justus Kolberg & Erik Simonsen

Easy to move thanks to a light frame, Moveo is even more flexible than your calendar. Optimum mobility is ensured by the perfectly designed wheels.

- 10 year warranty
- GreenTag^{Cert™}
- Inverted T-leg style
- Flip top table system



	Laminate (MRB)	Veneer (MRC)	Stained veneer (MRC)		
Laminate is with matching ABS edge. Veneer is with matching hardwood edge.	LU45 LU31 LU35 LU300 LU400 LU200	VU1 VU3 VU5 VU15	LW17 LW25 LW30	Linking	
Table top thickness is 1" B6 B51 B52 Standard frame* with castors with breaks *Other frame colours - see the notes	\$	\$	\$		\$
Rectangular	96"x42" (472V)	5983	7479	8487	304
Rectangular	96"x48" (471W)	6954	8692	9700	
Boat-shape	96"x42" (474M)	6879	8600	9608	304
Boat-shape	96"x48" (472W)	7605	9506	10514	

Price List 2024 - USD excl. sales tax - Version 1.1

Moveo Conference, Stand alone - custom size ranges

Rough, reference information - please verify custom sizes with CS, especially for non-rectangular tabletops

Rectangle: length 48"-100" | width 36"-48"

Moveo modesty panel

By Justus Kolberg & Erik Simonsen

Easy to move thanks to a light frame, Moveo is even more flexible than your calendar. Optimum mobility is ensured by the perfectly designed wheels.

- 10 year warranty



	Laminate	Veneer
MODESTY PANEL	LU45 ● LU31 ● LU35 ● LU300 ◻ LU400 ● LU200 ●	VU1 ● VU3 ● VU5 ● VU15 ● LW17 ● LW25 ● LW30 ●
Moveo modesty panel 0.35" thick and 10" high, mounted on hooks.		
	\$	\$
Beam length 975 mm (4C4C)	484	684
Beam length 1275 mm (4E4E)	532	752
Beam length 1575 mm (4H4H)	532	752

Price List 2024 - USD excl. sales tax - Version 1.1

Simpla

By John Bollen

The unique folding system makes Simpla radically different. In addition to a minimalist and elegant silhouette, the two-piece table is flexible and space-saving.

- Lift off top
- Unique flat folding frame
- Up to 8 stacked tables on a transporter
- 5 year warranty



		Laminate (SGB)	Veneer (SGC)		
Laminate is with a matching ABS edge Veneer is standard with matching hardwood edge.		LU31 LU35 LU45 LU200 LU300 LU400	VU1 VU3 VU5 VU15 LW17 LW25 LW30	Linking \$	
Table top thickness is 3/4" Standard frame with glides - optional to get glides and castors. Linking is incl. 2 brackets					
Rectangular	48"x24" (1L1L)	\$ 2326	\$ 2909	31	
Rectangular	60"x30" (1O1O)	2512	3141		
Rectangular	72"x36" (1R1R)	2775	3469		
Square	30"x30" (1Z1Z)	2245	2807	31	
Half-round	60"x30" (1E1E)	2690	3363	31	

Price List 2024 - USD excl. sales tax - Version 1.1

2 glides and 2 castors 20 \$

Simpla - custom size ranges

Rough, reference information - please verify custom sizes with CS, especially for non-rectangular tabletops

Rectangle: width 12"-40" | length 24"-80"

Square: 24"x24" - 48"x48"

Round: Ø34" - Ø48"

Half-round: 48"x24" - 80"x40"

Bar height is NOT available.

Reinforcement applied when the length is 64" or more

Simpla

By John Bollen

The unique folding system makes Simpla radically different. In addition to a minimalist and elegant silhouette, the two-piece table is flexible and space-saving.

- Lift off top
- Unique flat folding frame
- 5 year warranty

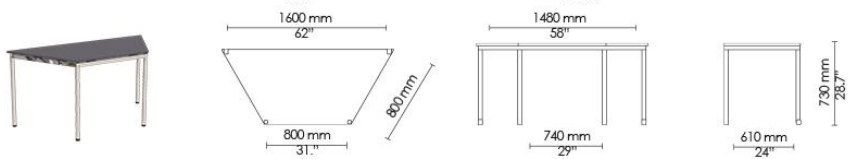
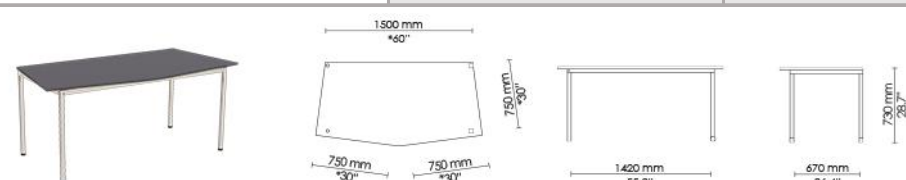

		Laminate (SGB)	Veneer (SGC)	
Laminate is with a matching ABS edge Veneer is standard with matching hardwood edge. Table top thickness is 3/4" Standard frame with glides - optional to get glides and castors. Linking is incl. 2 brackets 		LU31 LU35 LU45 LU200 LU300 LU400	VU1 VU3 VU5 VU15 LW17 LW25 LW30	Linking
Trapezoid	60"x30" (1M2A)	\$ 2550	\$ 3187	\$ 31
				
V-Shaped	60"x30" (1E2C)	2755	3445	31
				
Round	Ø42" (1Z1J)	2670	3340	31
Round	Ø48" (2B1K)	2868	3587	

Price List 2024 - USD excl. sales tax - Version 1.1

2 glides and 2 castors 20 \$

Simpla - custom size ranges

Rough, reference information - please verify custom sizes with CS, especially for non-rectangular tabletops

Round: Ø34" – Ø48"

Bar height is NOT available.

Simpla modesty panel

By John Bollen

The unique folding system makes Simpla radically different. In addition to a minimalist and elegant silhouette, the two-piece table is flexible and space-saving.



Modesty panel		
Simpla modesty panel in perforated steel, 9.8" high, with integrated cable tray and hooks to hang it on the Simpla frame.		Steel (SPS)
Simpla modesty panel in acrylic, 0.16" thick and 9.8" high, made of greenish acrylic plastic, mounted on the hooks.		\$
For 48" tops	(3C3CGHY/DEDEY)	443
For 60" tops	(3D3DGHY/DHDHY)	517
For 72" tops	(3F3FGHY/DKDKY)	517

Price List 2024 - USD excl. sales tax - Version 1.1

Tempest flip top

By KOMPLOT Design

Detail is everything. It is why the Tempest flips, rolls and unfolds possibilities like no other table system in the world.

- 10 year warranty
- World's leading flip-top table system
- Nesting depth of 5.1"
- 6 tables can be stacked on table transporter
- Elegant elliptical leg-design
- **Quick ship - LINK**

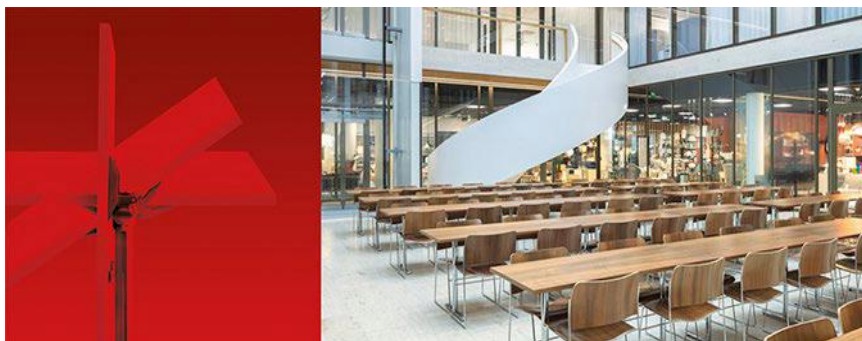

	Laminate (TPB)	Veneer (TPC)	Stained veneer (TPC)		
Laminate is with matching ABS edge	LU31 LU35 LU45 LU200 LU300 LU400	VU1 VU3 VU5 VU15	LW17 LW25 LW30	Linking	
Veneer is with matching hardwood edge. Other RAL colours available - ASK HOWE					
Table top thickness is 1 1/8"					
Standard frame with glides and castors	\$	\$	\$	\$	
Rectangular	48" x 24" (021B)	2021	3327	3831	304
Rectangular	48" x 30" (021M)	2078	3444	3948	
Rectangular	60" x 30" (021O)	2155	3601	4105	
Rectangular	72" x 30" (031Q)	2248	3758	4262	
Rectangular	72" x 36" (031R)	2480	3933	4437	
Rectangular	78" x 40" (031V)	2802	4266	4770	
V-Shape	60" x 30" (022C)	2647	4109	4613	N/A

Price List 2024 - USD excl. sales tax - Version 1.1

Tempest flip T/TT legs - custom size ranges

Rough, reference information - please verify custom sizes with CS, especially for non-rectangular tabletops

Rectangle: length 32"-80" | width 22"-42"

Bar height NOT available.











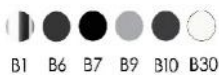





Tempest flip top

By KOMPLOT Design

Detail is everything. It is why the Tempest flips, rolls and unfolds possibilities like no other table system in the world.

- 10 year warranty
- World's leading flip-top table system
- Nesting depth of 5.1"
- 6 tables can be stacked on table transporter
- Elegant elliptical leg-design
- GreenTag^{Cert™}

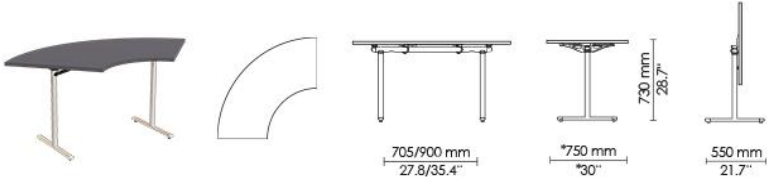

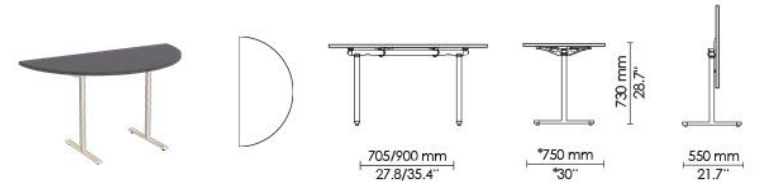
		Laminate (TPB)	Veneer (TPC)	Stained veneer (TPC)	
Laminate is with matching ABS edge Veneer is with matching hardwood edge. Other RAL colours available - ASK HOWE  B1 B6 B7 B9 B10 B30 Table top thickness is 1 1/8" Standard frame with glides and castors		LU31  LU35  LU45  LU200  LU300  LU400 	VU1  VU3  VU5  VU15 	LW17  LW25  LW30 	Linking
		\$	\$	\$	\$
					
Crescent	48" x 30" (021C)	3071	4640	5144	304
Crescent	60" x 30" (021D)	3411	5064	5568	
					
Trapezoid	60" x 30" (012A)	2334	3718	4222	N/A
					
Half-round	60" x 30" (021E)	2302	3679	4183	152

Price List 2024 - USD excl. sales tax - Version 1.1

Tempest fold

By KOMPLOT Design

Detail is everything. It is why the Tempest flips, rolls and unfolds possibilities like no other table system in the world.

- 10 year warranty
- Inverted elliptical T-leg style
- Legs: concealed wheel + adjustable glides
- 5 tables can be stacked on table transporter



	Laminate (TDB)	Veneer (TDC)	Stained veneer (TDC)		
Laminate is with matching ABS edge	LU31 LU35 LU45 LU200 LU300 LU400	VU1 VU3 VU5 VU15	LW17 LW25 LW30	Linking	
Veneer is with matching hardwood edge. Other RAL colours available - ASK HOWE					
Table top thickness is 1 1/8"					
Standard frame with glides and castors	\$	\$	\$	\$	
Conference					
Rectangular	84" x 42" (051S)	4608	5760	5760	304
Rectangular	96" x 48" (051W)	5094	6368	6368	

Price List 2024 - USD excl. sales tax - Version 1.1

Tempest fold T/T legs - custom size ranges

Rough, reference information - please verify custom sizes with CS, especially for non-rectangular tabletops

Rectangle: length 40"-96" | width 22"-48"

Bar height NOT available.

















Tempest fix

By KOMPLOT Design

Detail is everything. It is why the Tempest flips, rolls and unfolds possibilities like no other table system in the world.

- 10 year warranty
- Inverted elliptical T-leg style
- Legs: concealed wheel + adjustable glides
- GreenTag^{Cert™}

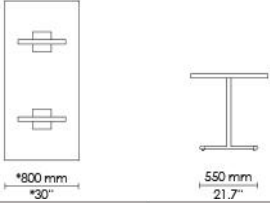

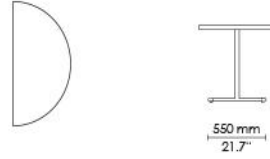
		Laminate (T12)	Veneer (T13)	Stained veneer (T13)	
Laminate is with matching ABS edge Veneer is with matching hardwood edge. Other RAL colours available - ASK HOWE  B1 B6 B7 B9 B10 B30 Table top thickness is 1 1/8" Standard frame with glides and castors		LU31  LU35  LU45  LU200  LU300  LU400 	VU1  VU3  VU5  VU15 	LW17  LW25  LW30 	Linking
 		\$	\$	\$	\$
Rectangular	48" x 24" (061L)	2378	2971	3464	304
Rectangular	48" x 30" (061M)	2464	3079	3572	
Rectangular	60" x 30" (061O)	2578	3221	3714	
Rectangular	72" x 30" (061Q)	2686	3356	3849	
Rectangular	72" x 36" (061R)	2814	3516	4009	
 					
Half-round	60" x 30" (061E)	2631	3288	3781	152

Price List 2024 - USD excl. sales tax - Version 1.1

Tempest fix T/TT legs - custom size ranges

Rough, reference information - please verify custom sizes with CS, especially for non-rectangular tabletops

Rectangle: length 32"-96" | width 22"-55"

Bar height NOT available.

Tempest fix

By KOMPLOT Design

Detail is everything. It is why the Tempest flips, rolls and unfolds possibilities like no other table system in the world.

- 10 year warranty
- Inverted elliptical T-leg style
- Legs: concealed wheel + adjustable glides
- GreenTag^{Cert}™



	Laminate (T12)	Veneer (T13)	Stained veneer (T13)	
<p>Laminate is with matching ABS edge</p> <p>Veneer is with matching hardwood edge. Other RAL colours available - ASK HOWE</p> <p>Table top thickness is 1 1/8"</p> <p>Standard frame with glides and castors</p>	<p>LU31 </p> <p>LU35 </p> <p>LU45 </p> <p>LU200 </p> <p>LU300 </p> <p>LU400 </p>	<p>VU1 </p> <p>VU3 </p> <p>VU5 </p> <p>VU15 </p>	<p>LW17 </p> <p>LW25 </p> <p>LW30 </p>	Linking
	\$	\$	\$	\$
Crescent 48" x 30" (061C)	3317	4144	4637	304
Crescent 60" x 30" (061D)	3617	4520	5013	
Trapezoid 60" x 30" (062A)	2659	3323	3816	N/A
V-Shape 60" x 30" (062C)	2935	3668	4161	N/A

Price List 2024 - USD excl. sales tax - Version 1.1

Tempest café flip top

By KOMPLOT Design

Detail is everything. It is why the Tempest flips, rolls and unfolds possibilities like no other table system in the world.

- 10 year warranty
- World's leading flip-top table system
- X-leg style with 4 adjustable glides
- Elegant elliptical leg-design
- GreenTag^{Cert™}
- Table base is 100% recyclable

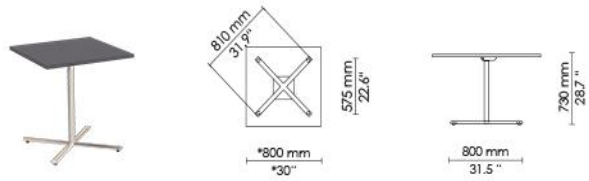
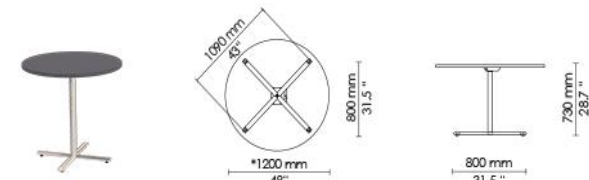

		Laminate (TLB)	Veneer (TLC)	Stained veneer (TLC)	
Laminate is with matching ABS edge Veneer is with matching hardwood edge. Other RAL colours available - ASK HOWE  B1 B6 B7 B30 Table top thickness is 1 1/8" Standard frame with 4 glides		LU31 LU35 LU45 LU200 LU300 LU400	VU1 VU3 VU5 VU15	LW17 LW25 LW30	Linking
		\$	\$	\$	\$
					
Square	30" x 30" (121Z)	2048	2928	3307	304
					
Round	Ø30" (111H)	1935	3040	3419	N/A
Round	Ø36" (221I)	2058	3363	3742	
Round	Ø42" (321J)	2328	3762	4141	
Round	Ø48" (331K)	2382	3886	4265	

Price List 2024 - USD excl. sales tax - Version 1.1

Tempest flip cafe - custom size ranges

Rough, reference information - please verify custom sizes with CS, especially for non-rectangular tabletops

Square: 18"x18" – 40"x40"

Round: Ø24– Ø48"

Tempest café and lounge fix

By KOMPLOT Design

Detail is everything. It is why the Tempest flips, rolls and unfolds possibilities like no other table system in the world.

- 10 year warranty
- Fixed base
- X-leg style with 4 adjustable glides
- Elegant elliptical leg-design
- GreenTag^{CertTM}
- Table base is 100% recyclable



		Laminate (TNB)	Veneer (TNC)	Stained veneer (TNC)	
Laminate is with matching ABS edge					
Veneer is with matching hardwood edge. Other RAL colours available - ASK HOWE					
 B1 B6 B7 B30		LU31 LU35 LU45 LU200 LU300 LU400	VU1 VU3 VU5 VU15	LW17 LW25 LW30	Linking
Table top thickness is 1 1/8"					
Standard frame with 4 glides		\$	\$	\$	\$
Square	30" x 30" (121Z)	2023	2524	2902	304
Round	Ø30" (111H)	2113	2636	3014	N/A
Round	Ø36" (221I)	2275	2838	3216	
Round	Ø42" (321J)	2594	3236	3614	
Round	Ø48" (331K)	2694	3361	3739	
Lounge - height	24" x 24" (121Y)	1837	2324	2702	N/A

Price List 2024 - USD excl. sales tax - Version 1.1

Tempest fix cafe - custom size ranges

Rough, reference information - please verify custom sizes with CS, especially for non-rectangular tabletops

Square: 18"x18" - 40"x40"

Round: Ø24- Ø48"

Tempest bar flip top

By KOMPLOT Design

Detail is everything. It is why the Tempest flips, rolls and unfolds possibilities like no other table system in the world.

- 10 year warranty
- World's leading flip-top table system
- X-leg style with 4 adjustable glides
- Elegant elliptical leg-design
- GreenTag^{Cert™}
- Table base is 100% recyclable



	Laminate (TLB)	Veneer (TLC)	Stained veneer (TLC)		
Laminate is with matching ABS edge	LU31 LU35 LU45 LU200 LU300 LU400	VU1 VU3 VU5 VU15	LW17 LW25 LW30	Linking	
Veneer is with matching hardwood edge. Other RAL colours available - ASK HOWE					
Table top thickness is 1 1/8"					
Standard frame with 4 glides	\$	\$	\$	\$	
Square	30" x 30" (121Z)	2074	2969	3348	304
Square	36" x 36" (232L)	2317	3255	3634	
Round	Ø30" (111H)	1962	3081	3460	N/A
Round	Ø36" (221I)	2084	3444	3823	

Price List 2024 - USD excl. sales tax - Version 1.1

Tempest flip bar - custom size ranges

Rough, reference information - please verify custom sizes with CS, especially for non-rectangular tabletops

Square: 18"x18" – 40"x40"

Round: Ø24" – Ø40"















Tempest bar fix

By KOMPLOT Design

Detail is everything. It is why the Tempest flips, rolls and unfolds possibilities like no other table system in the world.

- 10 year warranty
- Fixed base
- X-leg style with 4 adjustable glides
- Elegant elliptical leg-design
- GreenTag^{Cert™}
- Table base is 100% recyclable

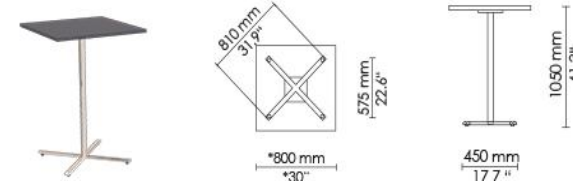
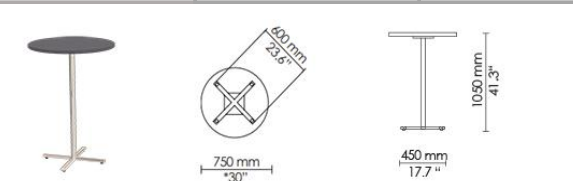

		Laminate (TNB)	Veneer (TNC)	Stained veneer (TNC)	
Laminate is with matching ABS edge					
Veneer is with matching hardwood edge. Other RAL colours available - ASK HOWE					
 B1 B6 B7 B30		LU31  LU35  LU45  LU200  LU300  LU400 	VU1  VU3  VU5  VU15 	LW17  LW25  LW30 	Linking
Table top thickness is 1 1/8"					
Standard frame with 4 glides		\$	\$	\$	\$
					
Square	30" x 30" (121Z)	2064	2565	2943	304
Square	36" x 36" (232L)	2206	2730	3108	
					
Round	Ø30" (111H)	2154	2677	3055	N/A
Round	Ø36" (221I)	2356	2919	3297	

Price List 2024 - USD excl. sales tax - Version 1.1

Tempest fix bar - custom size ranges

Rough, reference information - please verify custom sizes with CS, especially for non-rectangular tabletops

Square: 18"x18" – 40"x40"

Round: Ø24" – Ø40"









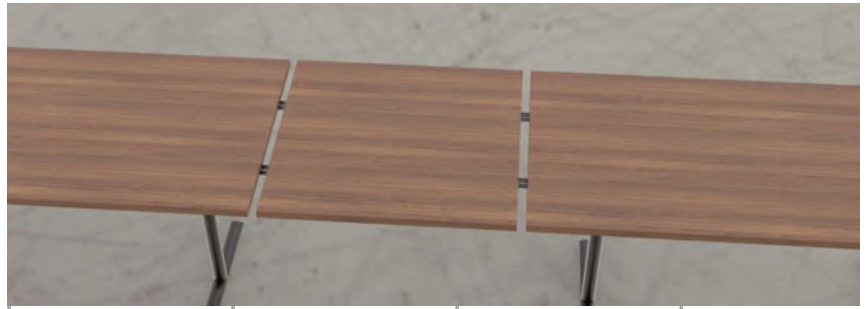



Tempest drop-in top

By KOMPLOT Design

Detail is everything. It is why the Tempest flips, rolls and unfolds possibilities like no other table system in the world.

- 10 year warranty



	Laminate (TTB)	Veneer (TTC)	Stained Veneer (TTC)
<p>Laminate is with matching ABS edge</p> <p>Veneer is with matching hardwood edge.</p> <p>Top thickness is 1 1/8"</p> <p>They can be placed only in straight line between two other tables with straight edges: Linking is included. They cannot be equipped with any accessories.</p>	<p>LU31 </p> <p>LU35 </p> <p>LU45 </p> <p>LU200 </p> <p>LU300 </p> <p>LU400 </p>	<p>VU1 </p> <p>VU3 </p> <p>VU5 </p> <p>VU15 </p>	<p>LW17 </p> <p>LW25 </p> <p>LW30 </p>
	\$	\$	\$
<p>Square 30" x 30" (1Z1Z)</p>	949	1116	1465

Price List 2024 - USD excl. sales tax - Version 1.1

Tempest modesty panel

By KOMPLOT Design

Detail is everything. It is why the Tempest flips, rolls and unfolds possibilities like no other table system in the world.

- 10 year warranty



		Laminate	Veneer	Stained veneer
MODESTY PANEL - Hook (MH)		<ul style="list-style-type: none"> ● LU31 ● LU35 ● LU45 ● LU200 ○ LU300 ● LU400 	<ul style="list-style-type: none"> ● VU1 ● VU3 ● VU5 ● VU15 	<ul style="list-style-type: none"> ● LW17 ● LW25 ● LW30
Rectangular modesty panel, on hooks, panel height 9,8". Suitabe for rectangular flip-top, fold or fixed tables. *standard colour, same as tabletop				
		\$	\$	\$
Rectangular	30" long tops (3A3A)	444	644	821 *
Rectangular	48" long tops (3C3C)	471	679	856 *
Rectangular	60" long tops (3D3D)	524	732	909 *
Rectangular	72" long tops (3F3F)	548	756	933 *
MODESTY PANEL - Demountable				
Rectangular modesty panel, on hooks, panel height 9,8". Suitabe for rectangular flip-top or fixed tables. *standard colour, same as tabletop		Laminate	Veneer	Stained Veneer
Rectangular	30" long tops (3A3A)	467	667	844 *
Rectangular	48" long tops (3C3C)	496	705	882 *
Rectangular	60" long tops (3D3D)	549	758	935 *
Rectangular	72" long tops (3F3F)	573	781	958 *
MODESTY PANEL - Retractable				
Rectangular modesty panel, on hooks, panel height 9,8". Suitabe for rectangular fold tables. *standard colour, same as tabletop		Laminate	Veneer	Stained Veneer
Rectangular	30" long tops (3A3A)	787	987	1164 *
Rectangular	48" long tops (3C3C)	816	1025	1202 *
Rectangular	60" long tops (3D3D)	869	1078	1255 *
Rectangular	72" long tops (3F3F)	893	1101	1278 *

*Color fee of USD 135 per color per order

Price List 2024 - USD excl. sales tax - Version 1.1













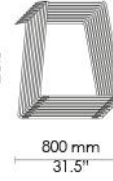

Tutor

By John Bollen

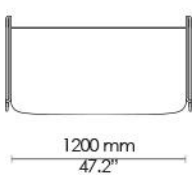
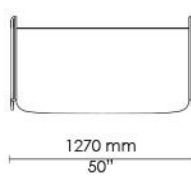
This stackable table pays tribute to the iconic 40/4 chair, and in the process, becomes an icon itself.

- Up to 30 tables can be stacked on dolly
- Up to 10 tables can be stacked on floor
- Use in education and training establishments
- 5 year warranty

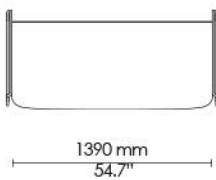
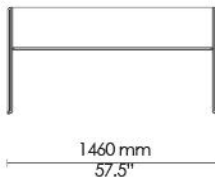

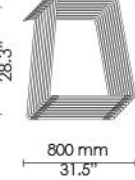
		Compact Laminate (OFA)			
Table top thickness is 1/4" bendable compact laminate. Other compact laminate colours: ask HOWE Other RAL colours - ask HOWE		F300 	F200 	With felt glides (F)	
 B1 B7 B9 B10 B30		\$		\$	
     600 mm / 23.6" 670 mm / 26.4" 665 mm / 26.2" 720 mm / 28.3" 800 mm / 31.5" 905 mm / 35.6"		Single table 23.6" (AA)		1150 1177	
     1200 mm / 47.2" 1270 mm / 50" 665 mm / 26.2" 720 mm / 28.3" 800 mm / 31.5" 905 mm / 35.6"		Double table 47.2" (BA)		1684 1711	
*Suitable for side chairs					
     1390 mm / 54.7" 1460 mm / 57.5" 665 mm / 26.2" 720 mm / 28.3" 800 mm / 31.5" 905 mm / 35.6"		*Double table 54.7" (CA)		2037 2064	
*Suitable for armchairs and swivel chairs					

Price List 2024 - USD excl. sales tax - Version 1.1

Net price: RAL K7 colours for frame - see notes

HOWE table size ranges

Tutor US custom-size tabletops are not possible.

AS400

By Andreas Störiko

The AS series is highly inspired and highly functional. Combining elegance and utility with true mobility, the family of nesting chairs and tables leaves room for all imaginable purposes.

- 10 year warranty
- Café height tables
- Unbelievably easy to maneuver
- Intuitive flip-top mechanism
- Special handle allows to lift the AS tables
- Smart elastic cord firmly joins concave tables*
- Rubber bumper protects tables from scratches
- An infinite number of tables can then be nested together

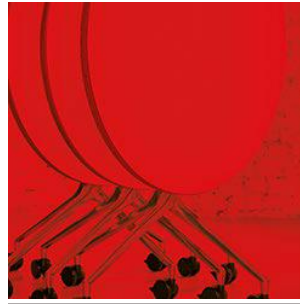

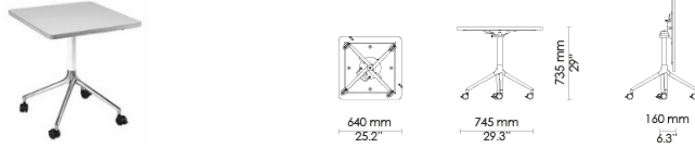
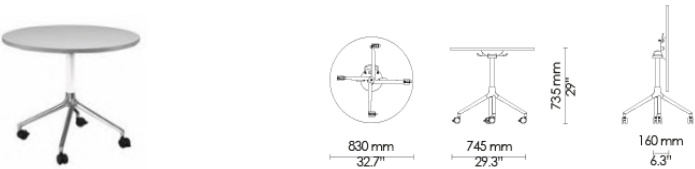
		Laminate (ABB)	Linoleum (ABD)	Veneer (ABC)
Table tops have an exposed plywood edge with transparent lacquer.		LU31 LU200 LU300 LU400	FL200	VU1 VU3
Other RAL colors available - ASK HOWE Standard base colors:				
				
		\$	\$	\$
Square	25.2" x 25.2" (*tiny pre-drills in the top; possibility to order linking later)	1314	1794	1949
Square with link	25.2" x 25.2"	1395	1875	2030
				
Round	Ø32.7"	1314	1794	1949
Concave with link	Ø32.7"	1422	1911	2074

Price List 2024 - USD excl. sales tax - Version 1.1

Soft castors for hard floor: 18 \$

HOWE table size ranges

AS400 Custom-size tabletops are not possible.







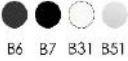

AS500

By Andreas Störiko

The AS series is highly inspired and highly functional. Combining elegance and utility with true mobility, the family of nesting chairs and tables leaves room for all imaginable purposes.

- 10 year warranty
- Bar height tables
- Unbelievably easy to maneuver
- Intuitive flip-top mechanism
- Special handle allows to lift the AS tables
- Smart elastic cord may join square tables together*
- Rubber bumper protects tables from scratches
- An infinite number of tables can then be nested together

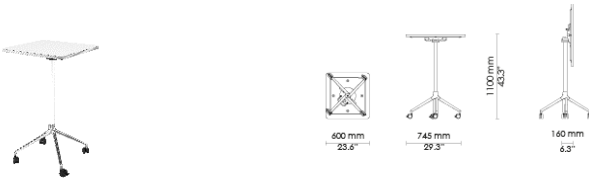
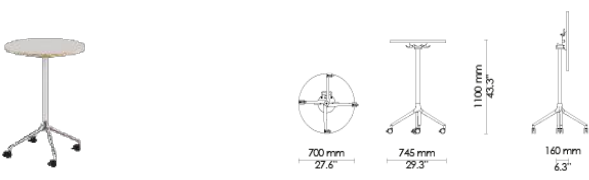

	Laminate (ADB)	Linoleum (ADD)	Veneer (ADC)	
<p>Table tops have an exposed plywood edge with transparent lacquer.</p> <p>Other RAL colors available - ASK HOWE Standard base colors:</p> 	LU31  LU200  LU300  LU400 	FL200 	VU1  VU3 	
	\$	\$	\$	
				
Square (*tiny pre-drills in the top; possibility to order linking later)	23.6" x 23.6"	1408	1901	2064
Square with link	23.6" x 23.6"	1489	1982	2145
				
Round	Ø27.6"	1408	1901	2064

Price List 2024 - USD excl. sales tax - Version 1.1

Soft castors for hard floors	18	\$
------------------------------	----	----

HOWE table size ranges

AS500 Custom-size tabletops are not possible.

Folding surfaces

By Jones & Partners

With Folding Surfaces, users gain the ability to adjust their office space as necessary. This innovative product concept allows users to unfold a surface wherever needed, thereby redefining workspace dynamics.

- Cleverly integrated power solutions
- One of the largest mobile double-folding benches on the market
- Fold and tuck away the tables when not in use
- Modern, aesthetic look
- Intuitive and effortless handling
- Surface levelling feature



	Melamine*	Laminate	Veneer*
	FS1	FS2	FS3
Melamine and laminate are standard with matching ABS edge. Veneer is with matching hardwood edge. Table top thickness is 25 mm - melamine; 27 mm laminate and veneer Standard B6 satin black frame, 4 castors.	M310*	LU200 LU300	V3*
	\$	\$	\$
Square 60" x 60" (1010)			
without electrification	3,140	4,200	4,580
Electrification cover top (CUT-OUTS ONLY) - incl. cover top, metal tray, felt cover. 2x cut-outs for battery, 2x cut-outs for pip (excl. battery and pip)	3,968	6,121	6,501
Electrification cover top (incl. pip, excl battery) - incl. cover top, metal tray, felt cover. 2x cut-outs for battery, 2x cut-outs for pip, interconnecting cables, pip, battery docking (excl. battery)	5,283	7,436	7,816
Rectangular 96" x 60" (6C6C)			
without electrification	3,660	5,200	5580
Electrification cover top (CUT-OUTS ONLY) - incl. cover top, metal tray, felt cover. 2x cut-outs for battery, 2x cut-outs for pip (excl. battery and pip)	4,860	7,628	8,008
Electrification cover top (incl. pip, excl battery) - incl. cover top, metal tray, felt cover. 2x cut-outs for battery, 2x cut-outs for pip, interconnecting cables, pip, battery docking (excl. battery)	6,175	8,943	9,323
Battery**			
Battery and high power USB charging module in a portable housing (all black)		1,461	

Price list 2024 - USD excl. V.A.T. - Version 1.1

* longer lead time

**Shipment only directly to the end customer or to a warehouse certified for storage and handling of dangerous goods
OE deliveries within North America may have shipping fee.

This depends on the order value and is shown separately in the offer.

Please contact Customer Service for details.

Accessories

Folding Surfaces Mobile Power Unit

As a natural extension for the family, Folding Surfaces come with mobile power units that provide extra power on demand.



Per Piece

\$

Folding Surfaces Mobile Power Unit		
White melamine		
Single, Rectangular 30"		
Semi solution - preparation for battery, 1xQikdoc for battery, 2xPIP TUF-R A+C (HP)	1576	
Cut-outs only - preparation for battery, 1xCUT-OUT for battery, 2x CUT OUTS for pip TUF-R A+C (HP)	1128	
Double, Rectangular 60"		
Semi solution - preparation for battery, 2xQikdoc for battery, 4xPIP TUF-R A+C (HP)	2423	
Cut-outs only - preparation for battery, 2xCUT-OUT for battery, 4x CUT OUTS for pip TUF-R A+C (HP)	1536	
Black laminate		
Single, Rectangular 30"		
Semi solution - preparation for battery, 1xQikdoc for battery, 2xPIP TUF-R A+C (HP)	2182	
Cut-outs only - preparation for battery, 1xCUT-OUT for battery, 2x CUT OUTS for pip TUF-R A+C (HP)	1734	
Double, Rectangular 60"		
Semi solution - preparation for battery, 2xQikdoc for battery, 4xPIP TUF-R A+C (HP)	3706	
Cut-outs only - preparation for battery, 2xCUT-OUT for battery, 4x CUT OUTS for pip TUF-R A+C (HP)	2819	
Battery*		
Quickpack carry black - OE animate battery and high power USB charging module in a neat, portable housing	1461	

Price list 2024 - EUR excl. V.A.T. - Version 1.1



*Shipment only directly to the end customer or to a warehouse certified for storage and handling of dangerous goods
 OE deliveries within North America may have shipping fee.
 This depends on the order value and is shown separately in the offer.
 Please contact Customer Service for details.

Accessories

Tables' transporters

HOWE combines simplicity and functionality with a focus on timeless originality. In every moving detail. This is why our furniture stacks, folds, rolls and creates flexible solutions like no other designs in the world.



Tempest Flip-top		No.	Per Piece	
Capacity up to 5 tables standing up (flipped position). Dimensions: 38" high, 79" long and 36" wide. MDF platform, metal powdercoated in B10 Howe grey.				
Transporter	Tempest	TFTS0110	\$	
Tempest Fold			Per Piece	
Capacity: up to 10 pcs Stacks on table edge, secured with straps. Top against top - base against base. Colour B10 Howe grey. Dimensions: 44.5" high x 79" long x 22" wide. Suitable for length 48"-72" and width 24"-36".				
A-kit big	Tempest	UNTAS000110	\$	
Tempest Fold			Per Piece	
Capacity w/rectangular tables: up to 5 pcs Capacity w/ all other shapes: up to 5 pcs Stacks on table edge, secured with straps. Top against top - base against base. Colour B10 Howe grey. Dimensions: 49.5" high x 79" long x 30.5" wide. Suitable for length 84"-96" and width 42"-48" (when rectangular).				
L-kit	Tempest	UNTLS000310	\$	
			2317	



Price List 2024 - USD excl. sales tax - Version 1.1

Accessories

Tables' transporters cont.

HOWE combines simplicity and functionality with a focus on timeless originality. In every moving detail. This is why our furniture stacks, folds, rolls and creates flexible solutions like no other designs in the world.



Simpla		No.	Per Piece	
Capacity up to 8 tables. Colour B10 Howe grey. Dimensions: height 74.5", depth 33", adjustable width Suitable for rectangular tables: length 40"-72" and width up to 36". For other shapes and sizes, please ask HOWE.				
Transporter	Simpla	STRA1000000 010	\$ 3003	
Tutor single size			Per Piece	
Capacity up to 30 tables. Suitable for single size Tutor tables. Color B10 Howe grey.				
Transporter	Tutor	OLYS0600SF1 0	\$ 1788	
Tutor double size			Per Piece	
Capacity up to 30 tables. Suitable for double size Tutor tables. Colour B10 Howe grey.				
Transporter	Tutor	OLYS1200SS1 0	\$ 2145	

Price List 2024 - USD excl. sales tax - Version 1.1

Accessories

Linking

HOWE combines simplicity and functionality with a focus on timeless originality. In every moving detail. This is why our furniture stacks, folds, rolls and creates flexible solutions like no other designs in the world.



		No.	Per Piece	
			\$	
Linking for Simpla tables				
Simpla linking U-bracket, B1 Chrome, 1 pcs*			Per Piece	
			\$	
Linking	Simpla	SAU01	31	
Linking for Tutor tables				
Tutor linking bracket, B7 Black			Per Piece	
			\$	
Linking Tutor		TUA1480	36	
Linking for Tutor tables				
Tutor file tray* linking, B30 White			Per Piece	
			\$	
Linking	Tutor	TUA1490	286	

Price List 2024 - USD excl. sales tax - Version 1.1



Accessories

Grommets

HOWE combines simplicity and functionality with a focus on timeless originality. In every moving detail. This is why our furniture stacks, folds, rolls and creates flexible solutions like no other designs in the world.

All electrification solutions must be consulted with HOWE's Customer Service Team.



Round	No.	Per Piece	
SAPOP; white plastic Ø2 3/4"; suitable top thickness ≥ 3/4".			
		\$	
	SAPOP	49	
Round		Per Piece	
SAPOA; nature anodized aluminium with black brush, Ø3.5"; suitable top thickness ≥ 3/4".			
		\$	
	SAPOA	136	
Rectangular		Per Piece	
SAPRA ¹ ; rectangular cable outlet comprised of two lids in nature anodized aluminium with black brushes; 12" x 4.25"; suitable top thickness ≥ 3/4".			
		\$	
	M1*	172	

Price List 2024 - USD excl. sales tax - Version 1.1

Accessories

Electrification

HOWE combines simplicity and functionality with a focus on timeless originality. In every moving detail. This is why our furniture stacks, folds, rolls and creates flexible solutions like no other designs in the world.

All electrification solutions must be consulted with HOWE's Customer Service Team.



Quickpack carry*	No.	Type	Prices from*	 
Quickpack carry black - OE animate battery and high power USB charging module in a neat, portable housing	OE4387596	Black	\$ 1461	
	OE4387602	White	1461	
Quick dock			Prices from	
Quick dock black by OE - dedicated container for QIKPAC CARRY portable battery; it locates and secures in/under surfaces	OE438765744	Black	\$ 265	
	OE438766444	White	265	
Charger				
Charger by OE - charging station for up to 3 QIKPAC batteries	OE6002275	charger black	1429	
	OE6002268	charger white	1429	
Wireless charge			Prices from	
A wireless charger by AH Byrne called Qi Charging Puck. The sleek grommet design can be quickly installed in any worksurface, and once in place, provides cord-free, tangle-free power for any Qi-enabled device. Forget packing your own charger, simply place your smartphone or tablet on our puck's surface and it's powering up – all from a single outlet. Wireless. Effortless.	BE07643	wireless charger	\$ 119	

Price List 2024 - USD excl. sales tax - Version 1.1

*Shipment only directly to the end customer or to a warehouse certified for storage and handling of dangerous goods
 OE deliveries within North America may have shipping fee.
 This depends on the order value and is shown separately in the offer.
 Please contact Customer Service for details.

Accessories

Cable trays, channels & fittings

HOWE combines simplicity and functionality with a focus on timeless originality. In every moving detail. This is why our furniture stacks, folds, rolls and creates flexible solutions like no other designs in the world.

All electrification solutions must be consulted with HOWE's Customer Service Team.



Cable tray	No.	Per Piece
L-shaped cable tray in black coated steel; mounted with screws; for table top thickness ≥ 3/4"; height of cable tray is 4"; works as a low modesty panel.		\$
15.75"	CTLS040007	72
25"	CTLL064007	107
33"	CTLL084007	143
41"	CTLL104007	172
Clickable cable channel Tempest		Per Piece
Cable channel for Tempest, in chrome powder coated aluminium as standard ¹		\$
Tempest	CHT053051	72
Clickable cable channel Moveo		Per Piece
Cable channel for Moveo, in anodised aluminium as standard ¹		\$
Moveo	CHM42052	33
Cable holder		Per Piece
Grey plastic cable holder to guide cables underneath the tabletop; 1pc double holder		\$
All tables	082011	N/A





Price List 2024 - USD excl. sales tax - Version 1.1

Accessories

AS tables privacy screens

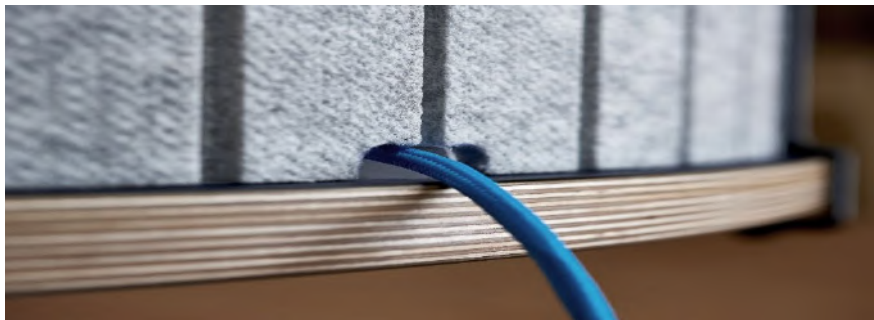
Aesthetically pleasing, the innovative felt privacy screen creates enclosure to spaces during work, education, and meeting areas. It gives flexibility to produce boundaries, as well as visual privacy.



Privacy screen	No.	Per Piece	
Privacy screen for AS round and round concave tables. 46.75"wide x13.75" high; 0.5 thick; light grey felt		\$	
Screen	66091001	572	

Price List 2024 - USD excl. sales tax - Version 1.1

Notes for tables

Price list 2024 - USD excl. V.A.T. - Version 1.1

General

HOWE Standard delivery time within North America is determined on a case-to-case basis – please contact Customer Service for details.

In case of large quantities and/or customized products delivery time is usually longer than for standard products.

In case of using any electrification, accessories, or making configurations, the lead time starts being counted once technical drawings are approved by the customer.

Linking is recommended to ensure strong connection and levelling. Please use for both temporary and lasting tables' arrangements.

Crescent shape – the inside curve of top may be exchanged for straight edge, especially if Modesty panels are needed – ask Customer Service for details.

Table ranges are estimates, mostly for rectangular tops. For non-rectangular tables or questions for sizes outside of the ranges, please contact your local Customer Service (CS) representative. If chamfered edges are requested, minimum size increases - check with CS.

Moveo

Moveo linking for rectangular and V-shaped tables includes 4 brackets and 4 fittings. Moveo linking for half-round and half-boat tables includes 2 brackets and 2 fittings. This type of linking is available for tables with straight edges only. Another linking type is available for tables with chamfered edges. Here you also get 4 brackets and 4 fittings for rectangular and V-shape tables and 2 brackets and 2 fitting for half-round and half-boat tables.

All RAL colours from RAL K5 or K7 colour card available. For quantities < 20 tables the colour fee is 520 USD per RAL colour. For quantities ≥ 20 tables there is no fee. Visual impression of particular RAL may differ on various surfaces. Preparing product's sample(s) is compulsory. Lead time to be confirmed by HOWE CS.

Simpla

Please note that Simpla linking does not need any pre-drills and may be ordered at any time as a separate accessory. There are 2 pcs of linking recommended per a set of two tables.

Please note that Modesty panels for Simpla are just hanged on the frame and may be ordered at any time as a separate accessory.

All RAL colours from RAL K5 or K7 colour card available. For quantities < 50 tables the colour fee is 520 USD per RAL colour. For quantities ≥ 50 tables there is no fee. Visual impression of particular RAL may differ on various surfaces. Preparing product's sample(s) is compulsory. Lead time to be confirmed by HOWE CS.

Tempest

Tempest linking for rectangular, crescent, and square tables includes 4 brackets and 4 fittings. Tempest linking for half-round tables includes 2 brackets and 2 fittings. This type of linking is available for tables with straight edges only. Another linking type is available for tables with chamfered edges. Please contact HOWE for options.

All RAL colours from RAL K5 or K7 colour card available. For quantities < 20 tables the colour fee is 520 USD per RAL colour. For quantities ≥ 20 tables there is no fee. Visual impression of particular RAL may differ on various surfaces. Preparing product's sample(s) is compulsory. Lead time to be confirmed by HOWE CS.

Tutor

All RAL colours from RAL K5 or K7 colour card available. For quantities < 50 tables the colour fee is 520 USD per RAL colour. For quantities ≥ 50 tables there is no fee. Visual impression of particular RAL may differ on various surfaces. Preparing product's sample(s) is compulsory. Lead time to be confirmed by HOWE CS.

40/4
Seats / backs
Natural wood
veneers



V1 - maple



V2 - beech



V3 - oak



V5 - cherry

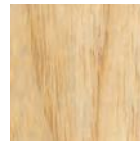

V12 - ash
EMEA ONLY



V13 - birch
EMEA ONLY



V15 - walnut

40/4
Seats / backs
Stains

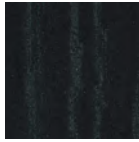

LW17 - black



LW30 - white



Any RAL

All RAL colours available
based upon customer sample

40/4
Seats / backs
Polyamide

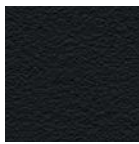

PA200 - black

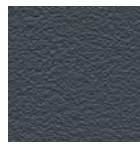

PA100 - Howe grey



PA300 - coconut



PA110 - Ayers Rock red

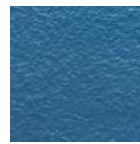

PA260 - marine blue

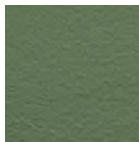

PA360 - olive green

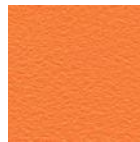

PA320 - mandarin

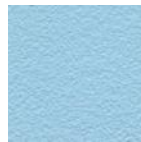

PA250 - blue eyes

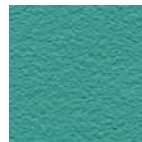

PA370 - mint turquoise



PA380 - aubergine

40/4
Seats / backs
Metal

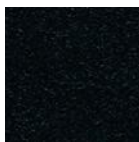

ME200 - black



ME300 - white



ME110 - red
EMEA ONLY



Any RAL

All RAL colours available
based upon customer sample

40/4
WOOD
FRAME
Seats / backs
Natural wood
veneers / stains



V2 - beech



V3 - oak



LW17 - black stain

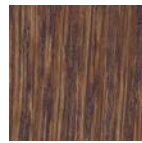

LW25 - walnut stain

SixE
Shells
Polypropylene

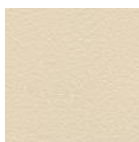

PP310 - wheat
VIRGIN

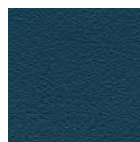

PP270 - ocean
VIRGIN

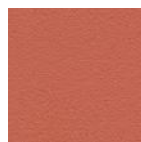

PP120 - red ochre
50% RECYCLED

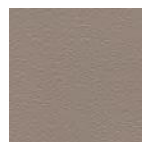

PP340 - fawn
VIRGIN



PP350 - lichen
VIRGIN

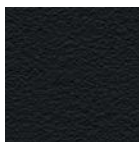

PP200 - black
VIRGIN OR
100% RECYCLED

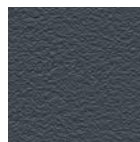

PP100 - Howe grey
100% RECYCLED

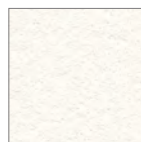

PP300 - chalk
VIRGIN OR
50% RECYCLED

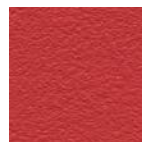

PP110 - Ayers Rock red
VIRGIN



PP360 - olive green
VIRGIN

CHAIRS

EMEA
NORTH AMERICA

MN1
Backs
Natural wood
veneers / stains



V3 - oak

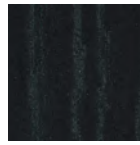

LW17 - black stain

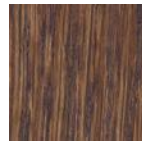

LW25 - walnut stain

40/4
SIXE
Frames
Steel



B1 - chrome

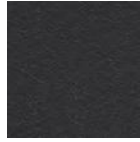

B6 - satin black



B7 - black



B9 - alu grey



B10 - Howe grey



B30 - white



Any RAL

All RAL colours
available based
upon customer
sample

SIXE
ONLY



Wheat



Ocean



Red Ochre



Fawn



Lichen

SIXE SWIVEL
SIXE LEARN
Base
Polyamide



PA100 - Howe grey

SIXE SWIVEL
SIXE LEARN*
Swing arm*
Gas lift



B10 - Howe grey

MN1
Bases



B1 - chrome
- Cantilever only



B7 - black



B51 - polished alu

AS100
Bases / seat
frames

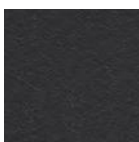

B6 - satin black



B7 - black



B51 - polished alu



AS TABLES
MOVEO
SIMPLA
TEMPEST

Tops
Natural wood
veneers / stains



VU1 - maple



VU3 - oak



VU5 - cherry

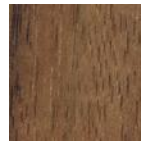

VU15 - walnut

AS tables standard:
VU1 maple, VU3 oak ONLY

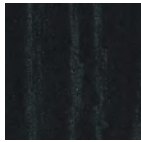

LW17 - black stain

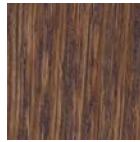

LW25 - walnut stain



LW30 - white stain



Any RAL

All RAL colors available
based upon customer sample

FOLDING SURFACES

Tops
Natural wood
veneers / stains



V3 - oak

AS TABLES
MOVEO
SIMPLA
TEMPEST

Tops
Wood grain
laminates



LU31 - maple

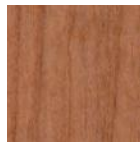

LU35 - cherry

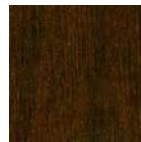

LU45 - walnut

AS tables standard:
LU31 maple ONLY

AS TABLES
FOLDING SURFACES
MOVEO
SIMPLA
TEMPEST

Tops
Coloured
laminates



LU300 - white



LU400 - grey



LU200 - black



Any FORMICA /
WILSONART
colored laminates

Folding Surfaces standard:
LU300 white, LU200 black ONLY

*Any FORMICA / WILSONART
colored laminates does not
apply to Folding Surfaces

TUTOR

Tops
Bendable
compact
laminates

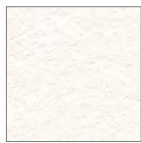

F300 - white

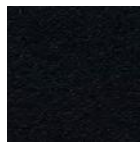

F200 - black



Any bendable
compact laminate

AS TABLES

Tops
Linoleums

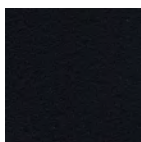

FL200 - black

FOLDING SURFACES

Tops
Melamines

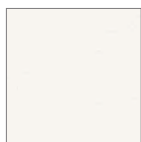

M310 - white



SIMPLA
TUTOR

Bases
Steel

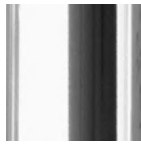

B1 - chrome



B7 - black



B9 - alu grey



B10 - Howe grey



B30 - white

TEMPEST

Bases
Steel

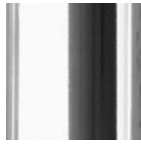

B1 - chrome



B6 - satin black

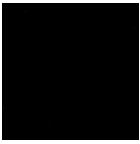

B7 - black



B9 - alu grey



B10 - Howe grey



B30 - white

MOVEO

Bases
Aluminum



B6 - satin black



B51 - polished alu
- feet only



B52 - anodized alu
- columns only

AS TABLES

Bases



B6 - satin black



B7 - black



B31 satin white
- columns only

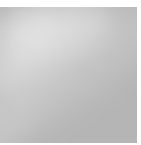

B51 - polished alu
- bases only

FOLDING SURFACES

Bases



B6 - satin black



TABLES
NORTH AMERICA



COLOUR REFERENCE ONLY
Variations in colours and structures may occur
Subject to ongoing changes and adjustments

→ [HOWE.COM](https://www.howe.com)

09.2024

General conditions of sales

Price list 2024 - USD excl. V.A.T. - Version 1.1

General

These general conditions of sale and terms of delivery shall apply to all agreements concluded between HOWE US Inc. (hereinafter HOWE) and its customers (hereinafter the Buyer), unless otherwise specifically agreed in writing between the Parties.

Conclusion of agreements, etc.

An agreement has not been concluded until HOWE has accepted an offer made by the Buyer by issuing an order acknowledgement, an invoice or other such written agreement based on the terms and conditions specified in this document. All prices stated in price lists and catalogues include packaging, such as pallets and transport containers, and exclude taxes and/or any other charges. HOWE reserves the right to adjust the prices stated without prior warning in case of an increase in the price of raw materials, production costs, transport costs, packaging, or other sudden changes in the cost level. All agreements are thus concluded on the basis of the prices in force at the time when the order is received.

The agreement basis is thus the information, including information relating to price, materials, qualities, etc., that is stated in the order acknowledgement, invoice, or other such agreement, since other information shall be deemed to be for guidance only and may be corrected up until but not later than the time when the agreement is concluded. Unless otherwise explicitly agreed in writing, the goods have been sold for normal, standard use for the intended purpose.

An Order shall constitute an offer for the sale of goods and does not constitute an acceptance by Buyer of any offer to sell, any quotation, or any proposal. No Order shall become a binding contract for the sale of goods unless and until such Order has been received and accepted by HOWE us Inc. in the state of Michigan.

Payment, etc.

Payment terms are subject to credit insurance at Coface. In case a customer cannot be insured a prepayment, or a bank guarantee will be required. If credit payment terms can be granted, payment shall be made in accordance with the terms of payment stated on the invoice, which basically means that payment shall be made in cash not later than 30 days after the date of invoice ("net 30 days"), unless otherwise explicitly agreed. The Buyer shall not be entitled to withhold any part of its' payments due and may under no circumstances offset. If payment is delayed, HOWE shall be entitled to charge interest at a rate of 0.75 % per month or part thereof from the due date. Also, HOWE shall at its' discretion be entitled to fully or partially withhold subsequent deliveries, to demand special terms of payment, or cancel agreements with the Buyer.

HOWE shall be entitled to charge the following fees:

- o A fee of thirteen (\$13) for each reminder on late payment
- o All invoices sent by paper will be added an invoice fee of five (\$5)

Property reservation

HOWE shall retain property in all the goods stated in the order acknowledgement or other such written agreement until the full purchase sum has been paid. The Buyer shall keep the goods fully insured until such time as the purchase sum has been paid and during this period the Buyer shall be responsible towards HOWE for any all and any damage suffered by the goods. HOWE has the right to inspect the goods at any time.

Delivery

'Unless otherwise agreed, delivery in Zone 1 in the US shall be made to the Buyer's warehouse situated on the ground floor at a price of two and a half (2½) % of the list price. Delivery in Zone 2 in the US shall be made to the Buyer's warehouse situated on the ground floor at a price of four and a half (4½) % of the list price. Outside Zone 1 and 2 the added price for delivery is determined on a case-to-case basis by HOWE.

HOWE Standard delivery time within North America is determined on a case-to-case basis – please contact Customer Service for details.

Regardless of whether the Buyer is present at the time of delivery, all risks in relation to the goods shall pass to the Buyer upon delivery to the agreed location. The Buyer shall ensure that the place of delivery is accessible and appropriately laid out for unloading the goods and storing them in their standard packages.

Any deviation from the terms of delivery shall be deemed to constitute one joint deviation from the above, in which case the Buyer shall take over the risk in relation to the goods at the earlier time when the goods were collected or could have been collected in accordance with the agreement made.

If the Buyer requests a postponement of delivery the following charges shall apply:

- o If the Buyer requests postponement no later than five workdays prior to the planned and confirmed time of dispatch, a supplementary charge of ten (\$10) per pallet shall be made per month or part thereof. Minimum charge, forty (\$40) per month or part thereof.
- o If the Buyer changes its' delivery address no later than five workdays prior to dispatch, an administrative charge of one hundred (\$100) shall be added.
- o If the sales price is below net five hundred (\$500) a freight charge of one hundred (\$100) will be added.
- o If the Buyer wishes a fixed delivery, a fee of five hundred (\$500) will be added.

BATTERIES' SHIPMENTS

OE batteries contain Lithium-Ion (Li-ion) cells which are classed as hazardous materials. As such they are individually packed in UN38.3 compliant packaging, including special Li Ion Battery Label. They should be kept in that packaging until they are either fitted in the furniture or get to the site for use.

If one consolidates the battery into an outer carton, it must remain in the box it is shipped to the person in inside the outer carton. The outer carton would then need to be marked with 'OVERPACK' word in English and the local language – the rules are even stricter for air freight - consult details with your freight forwarder (OE can supply UN38.3 certificates).

That is why at HOWE we:

- a) always place a separate order and use road shipments for batteries,
- b) strongly recommend shipping batteries directly to the end customer.

OE is experienced in shipping batteries to a number of international locations. Still, we strongly advise to state in advance to which country destination one is quoting for. On that basis we can confirm that battery export to the said country is allowed and possible.

In case the customer asks for the shipment to the warehouse, they must confirm the place is officially complying with all the regulations regarding storage and handling of dangerous goods which include:

- o Staff training on dangerous goods handling – chargeable course required (renewable every couple of years) – also a DGSA must to be appointed or trained,
- o Being equipped with fire proof cabinet storage,
- o Having Property owner and insurance authorisation.

Fee and MOQ for non-standard choices

For any non-standard product there is a \$500 fee. In most cases there is also a minimum order quantity (MOQ).

Buyers' cancellation of contract

Provided the manufacture/dispatch/delivery of the goods has not yet commenced the Buyer shall be entitled to cancel the contract up until forty-eight (48) hours after the order confirmation has been issued. A cancellation fee of 5% of the purchase sum and any extra loss incurred by HOWE as a consequence of the cancellation will apply. In the event more than five (5) workdays have passed since the order confirmation was issued, the contract may be cancelled only up until 4 (four) weeks before confirmed shipment time. A cancellation fee of fifty (50) % of the purchase sum plus transport and administration costs, and any extra loss incurred by HOWE as a consequence of the cancellation will apply. Following four (4) weeks before confirmed shipment time the contract cannot be cancelled.

Delays

The confirmed time of delivery is only an estimated deadline since HOWE shall be entitled to make changes to or temporarily postpone deliveries in order to be able to organize its goods deliveries and administration appropriately. HOWE cannot be held liable for any loss suffered by the Buyer as a result of a changed or postponed time of delivery. Furthermore, HOWE does not automatically offer loan furniture in these situations.

Deficiencies, etc.

HOWE shall only be liable for deficiencies in the goods sold if such deficiencies are the result of matters relating to the materials used or the craftsmanship applied. In particular, HOWE shall not be liable for matters resulting from wrong or abnormal use or storage, including in relation to climate and temperature conditions, or any other aspects related to HOWE's instructions.

When the risks in relation to the goods have passed to the Buyer, HOWE can only be held liable for faults and deficiencies to the extent specified in this provision.

The Buyer shall be obliged to carry out a detailed examination of the consignment immediately upon receipt. Complaints regarding deficiencies and/or visible transport damage which are – or should have been – discovered in this examination shall be written on the bill of landing (BOL), which must be given to carrier upon receipt of goods and HOWE CS notified. Any complaints regarding "non-visible" transport damage must reach HOWE not later than seven (7) days after the date of delivery and any complaints regarding any deficiencies ascertained must in each case be forwarded not later than seven (7) days after they were – or should have been – discovered. If the complaint is not made within these deadlines, the Buyer's access to advance claims in relation to any such deficiencies shall be forfeited.

A complaint shall be in writing and shall contain a specific description of the deficiencies with accompanying photo documentation or, alternatively, the deficient component/product shall be forwarded with the complaint.

Unless the deficiency ascertained is the result of gross negligence or intent on the part of HOWE, the Buyer shall in no instance not be entitled to any other rights than to have the goods replaced at no cost to the Buyer. Thus, the Buyer shall not be entitled to cancel the transaction or any rebate, damages, other compensation, or repayment. Further, HOWE shall under no circumstances whatsoever be liable for operating loss, loss of profit, time loss, other indirect loss or damages suffered by the Buyer as a consequence of deficiencies in the goods delivered.

The deficient goods belong to HOWE and shall be returned to HOWE upon request. Basically, the Buyer shall bear the costs and risk of such transport. Unless HOWE has explicitly undertaken to guarantee for the object sold for a longer period, HOWE shall under no circumstances be held liable for faults or deficiencies for which no written complaint has been sent within two years of the hand-over to the Buyer.

Product liability

The Buyer shall indemnify, defend, and hold harmless HOWE for any and all claims made by third parties for damage or injury for which HOWE is not liable towards the Buyer. HOWE's liability for product liability claims shall not exceed ten thousand (\$10,000), and HOWE shall under no circumstances be held liable to the Buyer for operating loss, loss of profit, time loss, other indirect loss or damages or punitive damages. The Buyer shall immediately inform HOWE of any lawsuit or type of claim for damage or injury caused by products manufactured by HOWE.

Design alterations

HOWE reserves the right at all times to make such changes to product design, etc., as HOWE deems to be necessary. In such case, information about significant alterations shall be forwarded to the Buyer prior to delivery.

Use and maintenance guides

The Buyer shall not change the content of Use- and Maintenance guides provided by HOWE. Further, the Buyer shall at all times provide its customers with copies of such guides and specifically draw the customers' attention to the warnings contained in the guides.

No waiver

If HOWE fails to exercise or claim its' rights under these Sales conditions, such failure shall not constitute a waiver of such right on the part of HOWE. Also, such failure shall not prevent the right to be invoked or claimed by HOWE at a later point in time.

Venue and Service of Process

If a dispute of any kind whatsoever arises between the Parties in connection with these Sales Conditions and other aspects in relation to the sales transaction, the Parties shall attempt to settle such dispute amicably.

Provided the Parties are not able to agree upon an amicable settlement within a reasonable time and not later than thirty (30) calendar days after initiation of settlement discussions, any controversy or claim arising (whether contractually or in tort) and including disputes regarding the validity of this provision shall be settled by the American Arbitration Association (AAA). The place of Arbitration shall be Grand Rapids, Michigan. Provided the dispute in question amounts to \$100,000.00 or less, the Arbitration Panel shall consist of one (1) arbitrator. Provided the dispute in question exceeds \$100,000.00 the Arbitration Panel

shall consist of three (3) arbitrators. The right to discovery shall be limited to the widest extent permitted by the AAA procedural rules.

The result of the Arbitration shall be final and binding upon the Parties, and the arbitrator(s) shall in their discretion have to power to award reasonable costs and attorney's fees to the prevailing Party.

Despite the arbitration procedure agreed upon above, the Parties shall not be precluded from carrying out interim measures via the appropriate judicial authority.

These Sales Conditions shall be governed by Michigan State law and applicable US Federal law.

Be advised that HOWE reserves the right to correct any printing errors, inaccuracies, or omissions.

Warranties

Price list 2024 - USD excl. V.A.T. - Version 1.1

General

At HOWE US we recognize the value of products that can stand up to continuous use, and we know by experience that good material combined with true craftsmanship and thorough design provides sturdy and durable furniture.

Our high and uniform quality policy secures that our products are always tested to the highest level of international standards and legislations. We constantly strive to optimize our products and services to maintain the high level of quality and durability that is expected of a HOWE product.

HOWE US warrants its products against defects in materials and workmanship as follows:

Limited warranty

HOWE warrants its' products against defects in materials and workmanship as described in the following. All warranties are expressly limited to the types of warranties offered. Thus, no other implied or express warranties shall apply.

10 year warranty

HOWE offers on all chairs of its David Rowland 40/4 chair collection a 10 (ten) year guarantee under normal use against weld breakages, defective material, workmanship, and performance. Only exception is the 40/4 wood frame, which has a 5 (five) year guarantee.

The 40/4 chair is compliant with the following tests in the ANSI/BIFMA X5.1-2011 Chair Test Standard:

- Back Strength
- Drop-Dynamic
- Seating Durability
- Backrest Durability-Non-Tilt
- Leg Strength

HOWE offers on Moveo and Tempest table systems, SixE, MN1 and AS chairs a 10 (ten) year guarantee under normal use against weld breakages, defective material, workmanship, and performance. Excluded are: gas lifts, turn / tilt mechanism, castors, folding adaptors, where 5 (five) year guarantee applies.

5 year warranty

HOWE offers on all other furniture products, except Folding Surfaces, a 5 (five) year guarantee under normal use against weld breakages, defective material, workmanship, and performance.

2 year warranty

On all power and data solutions we refer to our sub supplier. Their warranty period is 2 (two) years. The HOWE guarantee period runs from the date of shipment.

HOWE offers on AS privacy screens and Folding Surfaces a 2 (two) year guarantee under normal use against weld breakages, defective material, workmanship, and performance.

Exclusions

This warranty does not apply to product failure resulting from:

- Normal wear and tear
- Abuse, misuse, accidents, or repeated knocks
- Improper handling/usage or improper cleaning/maintenance
- Alteration or modification of the product

In addition, HOWE does not warrant:

- Changes in surface finishes due to aging, scratches, markings, stains, or other damage due to normal wear and tear, or due to contact with sharp or hard objects
- Changes in surface finishes due to exposure to light
- Oxidizing of outdoor treated frames
- Natural variations in wood grain or the presence of character marks. This includes matching of grains, colors, or textures of natural materials
- Customers own fabrics and leather (COL & COM)
- All service parts (meaning all moving and mechanical parts)
- Customized solutions
- Marks in fabric/leather after stacking of chairs
- For leather: Marks as scars, insect bites, fat creases and neck wrinkles. This is beauty marks that reflect the normal life of an animal.

HOWE recommends chromium plated steel frames on all 40/4 chairs where repeated handling is intended. Please, be aware that constant impacts from handling of painted linking chairs are likely to cause scratches and flaking over time. This is considered normal wear and tear and therefore not covered by the HOWE Warranty.

Original spare parts delivery guarantee

Furniture programs from HOWE US are designed with focus on durability and timeless design. In case a product should be discontinued all original spare parts are available for 5 (five) years from the date the discontinuation has been carried through. If a component to a discontinued product for some reason is not available, a corresponding product is offered instead.

In case David Rowlands 40/4 chair should be discontinued all original spare parts are available for 10 (ten) years from the date the discontinuation has been carried through. In case the Tempest and Moveo table systems or the SixE chair family should be discontinued all original spare parts are available for 10 (ten) years from the date the discontinuation has been carried through.

The guarantee does not apply to product and component modifications and enhancements.